

JVC

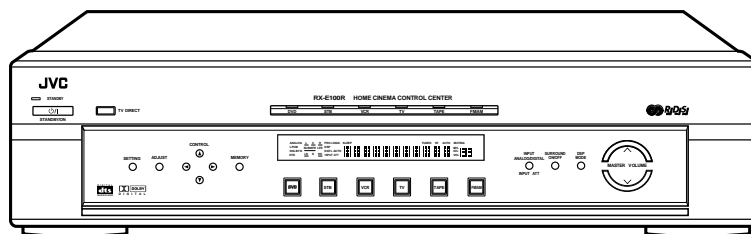

HOME CINEMA CONTROL CENTER

RX-E100RSL

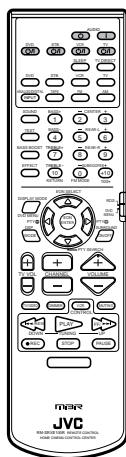

INSTRUCTIONS

For Customer Use:

Enter below the Model No. and Serial No. which are located either on the rear, bottom or side of the cabinet. Retain this information for future reference.

Model No. _____

Serial No. _____

LVT0650-003A

[B]

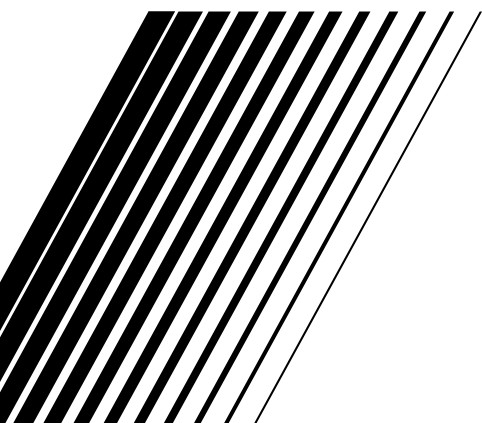

Warnings, Cautions and Others

IMPORTANT for the U.K.

DO NOT cut off the mains plug from this equipment. If the plug fitted is not suitable for the power points in your home or the cable is too short to reach a power point, then obtain an appropriate safety approved extension lead or consult your dealer.

BE SURE to replace the fuse only with an identical approved type, as originally fitted.

If nonetheless the mains plug is cut off ensure to remove the fuse and dispose of the plug immediately, to avoid a possible shock hazard by inadvertent connection to the mains supply.

If this product is not supplied fitted with a mains plug then follow the instructions given below:

IMPORTANT.

DO NOT make any connection to the terminal which is marked with the letter E or by the safety earth symbol or coloured green or green-and-yellow.

The wires in the mains lead on this product are coloured in accordance with the following code:

Blue : Neutral
Brown : Live

As these colours may not correspond with the coloured markings identifying the terminals in your plug proceed as follows:

The wire which is coloured blue must be connected to the terminal which is marked with the letter N or coloured black.

The wire which is coloured brown must be connected to the terminal which is marked with the letter L or coloured red.

IF IN DOUBT - CONSULT A COMPETENT ELECTRICIAN.

CAUTION

To reduce the risk of electrical shocks, fire, etc.:

1. Do not remove screws, covers or cabinet.
2. Do not expose this appliance to rain or moisture.

Caution — switch!

Disconnect the mains plug to shut the power off completely.

The  switch in any position does not disconnect the mains line. The power can be remote controlled.

CAUTION

- Do not block the ventilation openings or holes.
(If the ventilation openings or holes are blocked by a newspaper or cloth, etc., the heat may not be able to get out.)
- Do not place any naked flame sources, such as lighted candles, on the apparatus.
- When discarding batteries, environmental problems must be considered and local rules or laws governing the disposal of these batteries must be followed strictly.
- Do not use this apparatus in a bathroom or places with water. Also do not place any containers filled with water or liquids (such as cosmetics or medicines, flower vases, potted plants, cups, etc.) on top of this apparatus.

SAFETY INSTRUCTIONS

“SOME DOS AND DON'TS ON THE SAFE USE OF EQUIPMENT”

This equipment has been designed and manufactured to meet international safety standards but, like any electrical equipment, care must be taken if you are to obtain the best results and safety is to be assured.

Do read the operating instructions before you attempt to use the equipment.

Do ensure that all electrical connections (including the mains plug, extension leads and interconnections between pieces of equipment) are properly made and in accordance with the manufacturer's instructions. Switch off and withdraw the mains plug when making or changing connections.

Do consult your dealer if you are ever in doubt about the installation, operation or safety of your equipment.

Do be careful with glass panels or doors on equipment.

DON'T continue to operate the equipment if you are in any doubt about it working normally, or if it is damaged in any way—switch off, withdraw the mains plug and consult your dealer.

DON'T remove any fixed cover as this may expose dangerous voltages.

DON'T leave equipment switched on when it is unattended unless it is specifically stated that it is designed for unattended operation or has a standby mode.

Switch off using the switch on the equipment and make sure that your family know how to do this.

Special arrangements may need to be made for infirm or handicapped people.

DON'T use equipment such as personal stereos or radios so that you are distracted from the requirements of traffic safety. It is illegal to watch television whilst driving.

DON'T listen to headphones at high volume as such use can permanently damage your hearing.

DON'T obstruct the ventilation of the equipment, for example with curtains or soft furnishings.

Overheating will cause damage and shorten the life of the equipment.

DON'T use makeshift stands and NEVER fix legs with wood screws — to ensure complete safety always fit the manufacturer's approved stand or legs with the fixings provided according to the instructions.

DON'T allow electrical equipment to be exposed to rain or moisture.

ABOVE ALL

- NEVER let anyone, especially children, push anything into holes, slots or any other opening in the case -this could result in a fatal electrical shock.;
- NEVER guess or take chances with electrical equipment of any kind — it is better to be safe than sorry!

Caution: Proper Ventilation

To avoid risk of electric shock and fire and to protect from damage.

Locate the apparatus as follows:

- Front: No obstructions open spacing.
- Sides: No obstructions in 10 cm from the sides.
- Top: No obstructions in 10 cm from the top.
- Back: No obstructions in 15 cm from the back
- Bottom: No obstructions, place on the level surface.

In addition, maintain the best possible air circulation as illustrated.

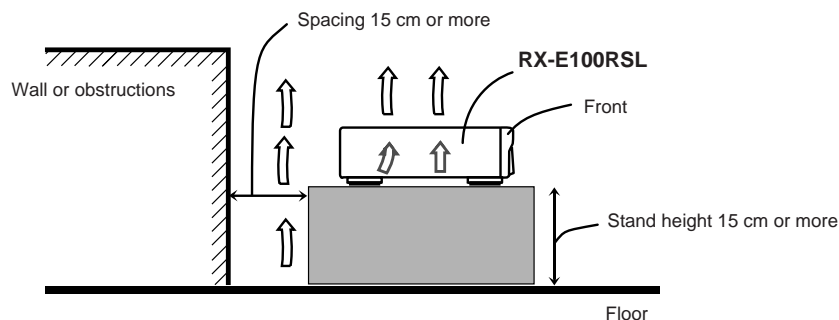

Parts Identification	2
Getting Started	3
Before Installation	3
Checking the Supplied Accessories	3
Putting Batteries in the Remote Control	3
Connecting the FM and AM (MW/LW) Antennas	4
Connecting the Speakers	5
Connecting Audio/Video Components	7
Connecting the Power Cord	9
Basic Operations	10
1 Turn On the Power	10
2 Select the Source to Play	10
3 Adjust the Volume	10
Activating TV Direct	11
Turning Off the Sounds Temporarily	12
Turning Off the Power with the Timer	12
Changing the Display Brightness	12
Basic Settings	13
Setting the Digital Input Terminals	13
Selecting the Analogue or Digital Input Mode	13
Setting the Subwoofer Information	15
Setting the Speakers for DSP Modes	15
Setting Auto Surround	18
Setting TV Direct Mode	19
Sound Adjustments	20
Attenuating the Input Signal	20
Adjusting the Front Speaker Output Balance	20
Reinforcing the Bass	21
Adjusting the Tone	21
Adjusting the Subwoofer Output Level	22
Tuner Operations	23
Tuning in Stations Manually	23
Using Preset Tuning	24
Selecting the FM Reception Mode	25
Using the RDS (Radio Data System) to Receive FM Stations	26
Searching for a Program by PTY Codes	27
Switching to a Broadcast Program of Your Choice Temporarily	29
Creating Realistic Sound Fields	30
About Relations between Speaker Layout and DSP Modes	32
Using Surround Modes (Remote Control)	33
Using Theatre Surround (Remote Control)	35
Using DAP Modes (Remote Control)	36
Using Surround Modes (Front Panel)	37
Using Theatre Surround (Front Panel)	38
Using DAP Modes (Front Panel)	39
Mastering Remote Operations	40
Troubleshooting	45
Specifications	46



This mark indicates that the remote control CAN ONLY be used for the operation explained.



This mark indicates that only the remote control CANNOT be used for the operation explained.

Parts Identification

Front Panel

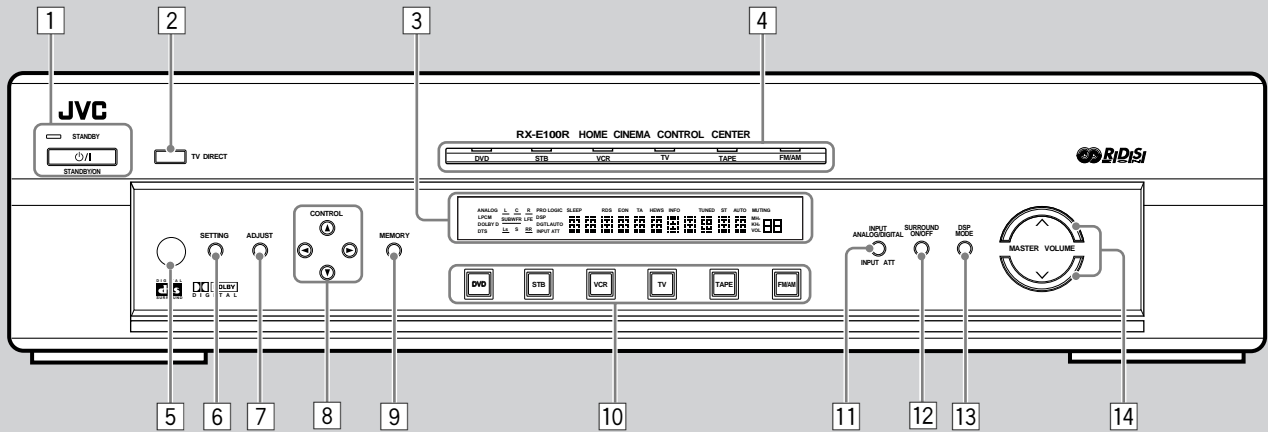

Remote Control

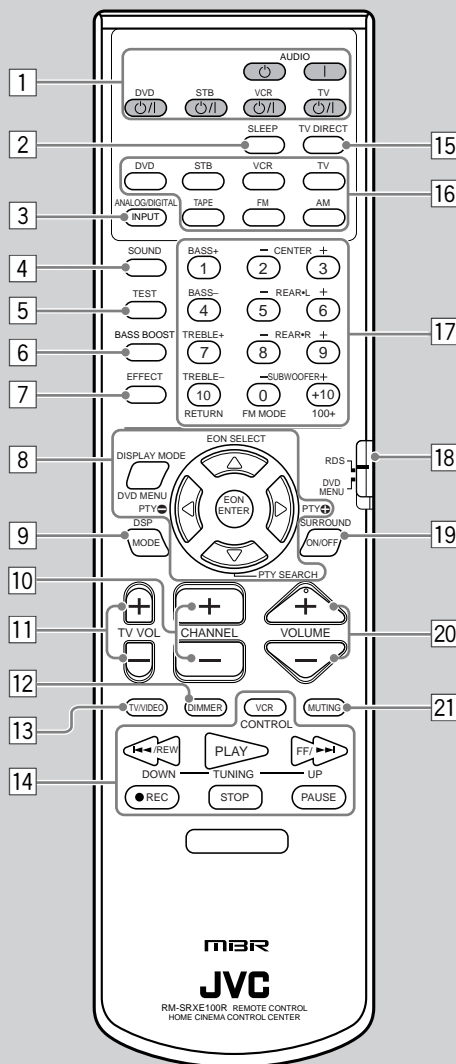

See pages in the parentheses for details.

Front Panel

- 1 STANDBY/ON button and STANDBY lamp (10)
- 2 TV DIRECT button (11)
- 3 Display
- 4 Source indicators
- 5 Remote sensor
- 6 SETTING button (13, 15, 17 – 19)
- 7 ADJUST button (20 – 22, 37 – 39)
- 8 CONTROL buttons (13 – 25, 37 – 39)
▲ / ▼ / ◀ / ▶
- 9 MEMORY button (24)
- 10 Source selecting buttons (10, 11, 14, 23, 25)
DVD, STB, VCR, TV, TAPE, FM/AM
- 11 INPUT ANALOG/DIGITAL button (14)
INPUT ATT button (20)
- 12 SURROUND ON/OFF button (32, 37)
- 13 DSP MODE button (32, 38, 39)
- 14 MASTER VOLUME ▲ / ▼ buttons (10)

Remote Control

- 1 POWER buttons (10, 40, 42, 43)
AUDIO , I, DVD , STB , VCR , TV
- 2 SLEEP button (12, 40)
- 3 ANALOG/DIGITAL INPUT button (14, 40)
- 4 SOUND button (21, 34 – 36, 40)
- 5 TEST button (33 – 35, 40)
- 6 BASS BOOST button (21, 40)
- 7 EFFECT button (35, 36, 40)
- 8 RDS/DVD MENU mode selector (26 – 28, 41, 42)
- 9 DSP MODE button (32, 35, 36, 40)
- 10 CHANNEL +/- buttons (41 – 43)
- 11 TV VOL +/- buttons (41, 43)
- 12 DIMMER button (12, 40)
- 13 TV/VIDEO button (41, 43)
- 14 Operating buttons for audio/video components (23, 41 – 43)
- 15 TV DIRECT button (11, 40)
- 16 Source selecting buttons (10, 11, 14, 23, 25, 40, 42, 43)
DVD, STB, VCR, TV, TAPE, FM, AM
- 17 • 10 keys for selecting preset channels (25, 41 – 43)
• 10 keys for adjusting sound (34 – 36, 41)
• 10 keys for operating audio/video components (41 – 43)
- 18 RDS/DVD MENU selector (26 – 28, 41, 42)
- 19 SURROUND ON/OFF button (32, 33, 38, 40)
- 20 VOLUME +/- buttons (10, 40)
- 21 MUTE button (12, 40)

Before Installation

General Precautions

- DO NOT insert any metal object into the unit.
- DO NOT disassemble the unit or remove screws, covers, or cabinet.
- DO NOT expose the unit to rain or moisture.

Locations

- Install the unit in a location that is level and protected from moisture.
- The temperature around the unit must be between 23°F and 95°F (-5°C and 35°C).
- Make sure there is good ventilation around the unit. Poor ventilation could cause overheating and damage the unit.

Handling the unit

- DO NOT touch the power cord with wet hands.
- DO NOT pull on the power cord to unplug the cord. When unplugging the cord, always grasp the plug so as not to damage the cord.
- Keep the power cord away from the connecting cords and the antenna. The power cord may cause noise or screen interference. It is recommended to use a coaxial cable for antenna connection, since it is well-shielded against interference.
- When a power failure occurs, or when you unplug the power cord, the preset settings such as preset FM/AM (MW/LW) channels and sound adjustments may be erased in a few days.

Checking the Supplied Accessories

Check to be sure you have all of the following supplied accessories. The number in the parentheses indicates the quantity of the pieces supplied.

- Remote Control (1)
- Batteries (2)
- AM (MW/LW) Loop Antenna (1)
- FM Antenna (1)

If anything is missing, contact your dealer immediately.

Putting Batteries in the Remote Control

Before using the remote control, put two supplied batteries first.

- When using the remote control, aim the remote control directly at the remote sensor on the unit.

1. On the back of the remote control, remove the battery cover.

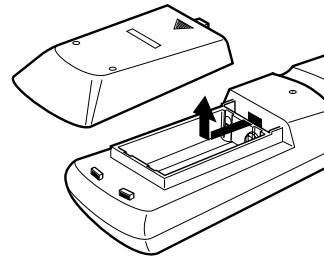

2. Insert batteries. Make sure to match the polarity: (+) to (+) and (-) to (-).

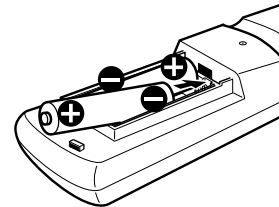

3. Replace the cover.

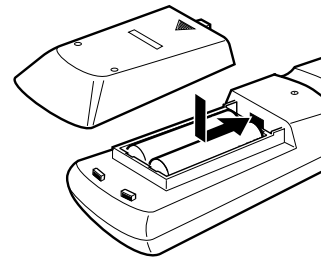

If the range or effectiveness of the remote control decreases, replace the batteries. Use two R6P(SUM-3)/AA(15F) type dry-cell batteries.

CAUTION:

Follow these precautions to avoid leaking or cracking cells:

- Place batteries in the remote control so they match the polarity: (+) to (+) and (-) to (-).
- Use the correct type of batteries. Batteries that look similar may differ in voltage.
- Always replace both batteries at the same time.
- Do not expose batteries to heat or flame.

Getting Started

Connecting the FM and AM (MW/LW) Antennas

AM (MW/LW) Loop Antenna (supplied)

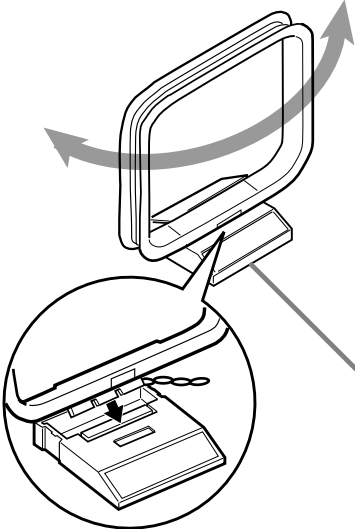

Snap the tabs on the loop into the slots of the base to assemble the AM (MW/LW) loop antenna.

If AM (MW/LW) reception is poor, connect single vinyl-covered wire (not supplied).

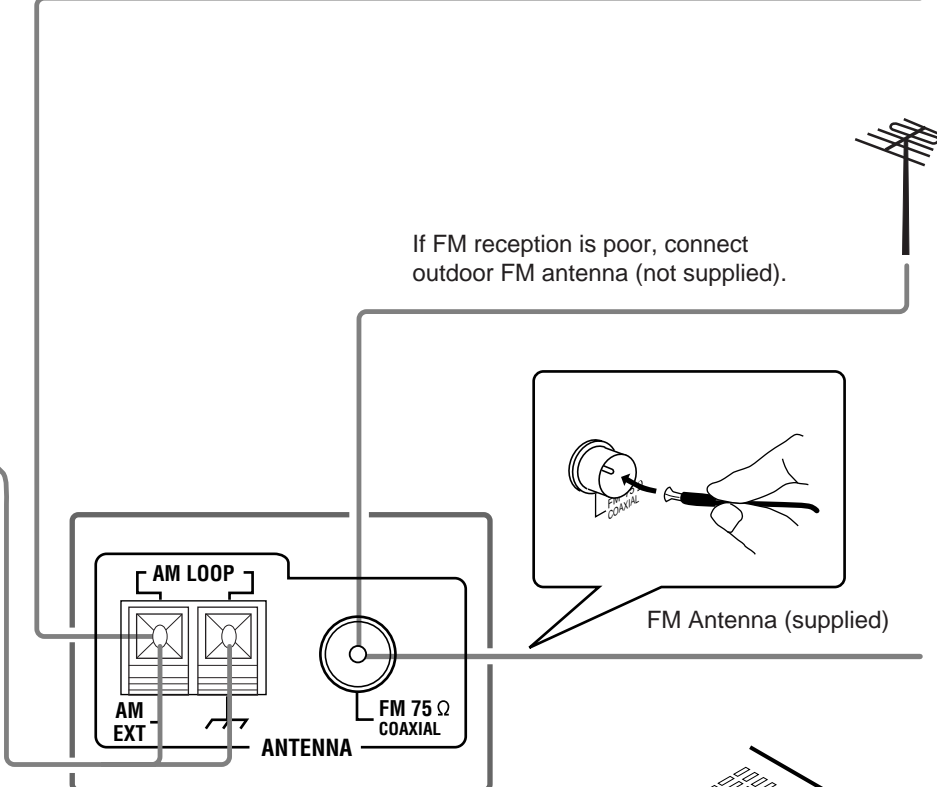

If FM reception is poor, connect outdoor FM antenna (not supplied).

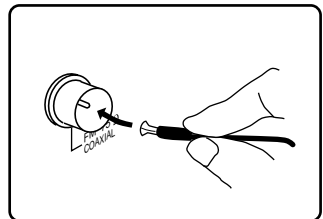

FM Antenna (supplied)

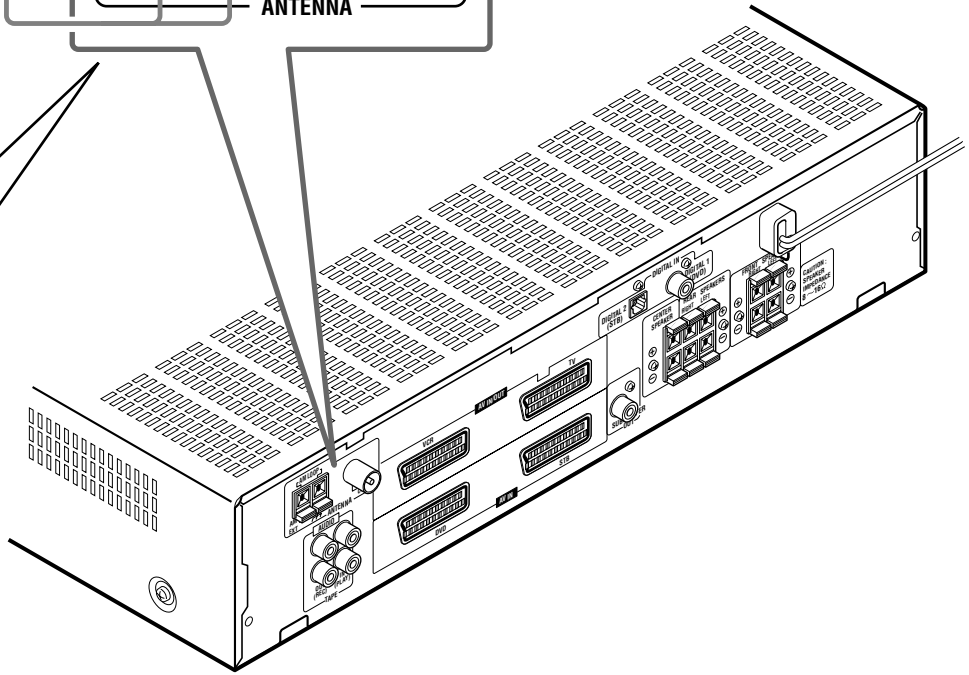
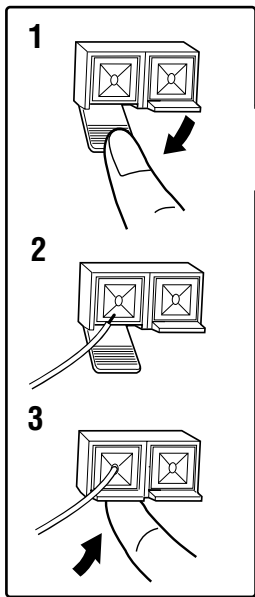

AM (MW/LW) antenna connection

Connect the AM (MW/LW) loop antenna supplied to the AM LOOP terminals.

Turn the loop until you have the best reception.

- If reception is poor, connect an outdoor single vinyl-covered wire to the AM EXT terminal. Keep the AM (MW/LW) loop antenna connected.

FM antenna connection

Connect the FM antenna supplied to the FM 75 Ω COAXIAL terminal as temporary measure.

Extend the supplied FM antenna horizontally.

- If reception is poor, connect an outdoor antenna. Before attaching a 75 Ω coaxial cable (with a standard type connector), disconnect the supplied FM antenna.

Notes:

- If the AM (MW/LW) loop antenna wire is covered with vinyl, remove the vinyl while twisting it as shown to the right.
- Make sure the antenna conductors do not touch any other terminals, connecting cords and power cord. This could cause poor reception.

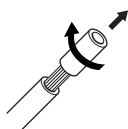
**Connecting the Speakers**

After connecting the front, center, rear speakers and/or a subwoofer, set the speaker setting information properly to obtain the best possible DSP effect. For details, see page 15.

CAUTION:

Use speakers with the SPEAKER IMPEDANCE indicated by the speaker terminals.

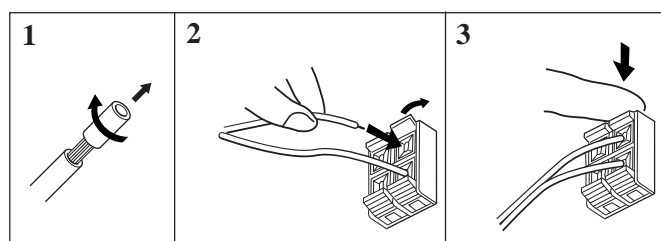
Connecting the front, center, and rear speakers

For each speaker, connect the (+) and (-) terminals on the rear panel to the (+) and (-) terminals marked on the speakers respectively.

- 1 **Cut, twist and remove the insulation at the end of each speaker cord (not supplied).**
- 2 **Open the terminal, then insert the speaker cord.**
- 3 **Close the terminal.**

Connecting the subwoofer speaker

By connecting a subwoofer, you can enhance the bass or reproduce the original LFE signals recorded in the digital software.

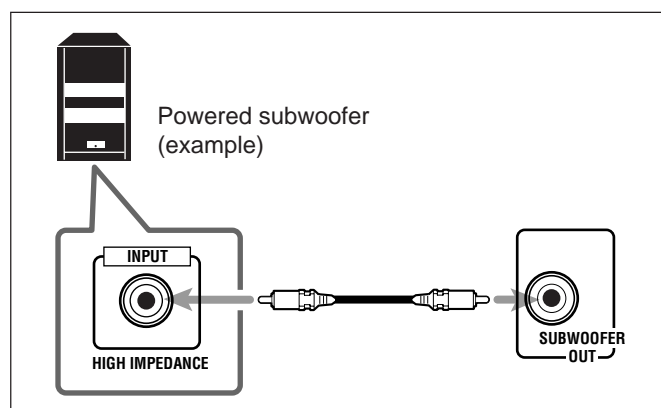

Connect the input jack of a powered subwoofer to the SUBWOOFER OUT jack on the rear panel, using a cable with RCA pin plugs (not supplied).

- Refer also to the manual supplied for your subwoofer.

Since bass sound is non-directional, you can place a subwoofer wherever you like. Normally place it in front of you.

Getting Started

Speaker Layout Diagram

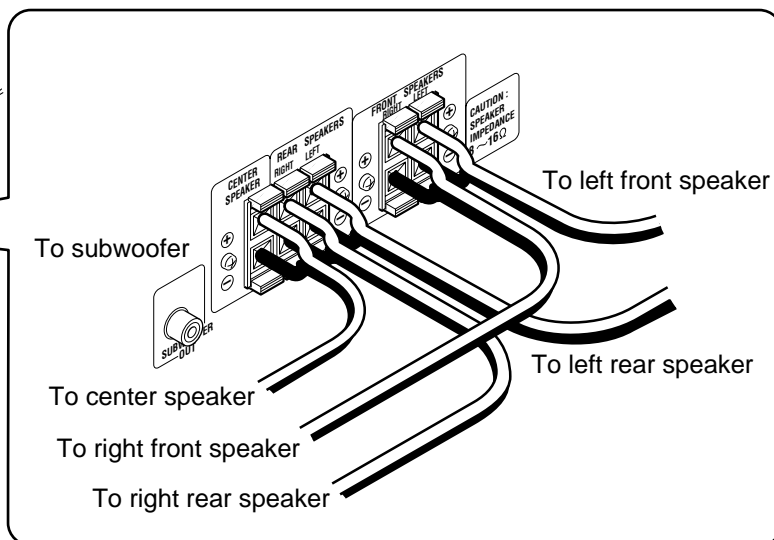
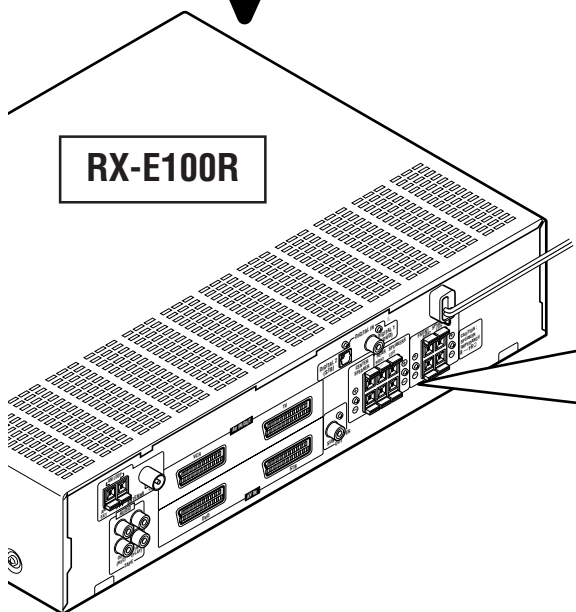
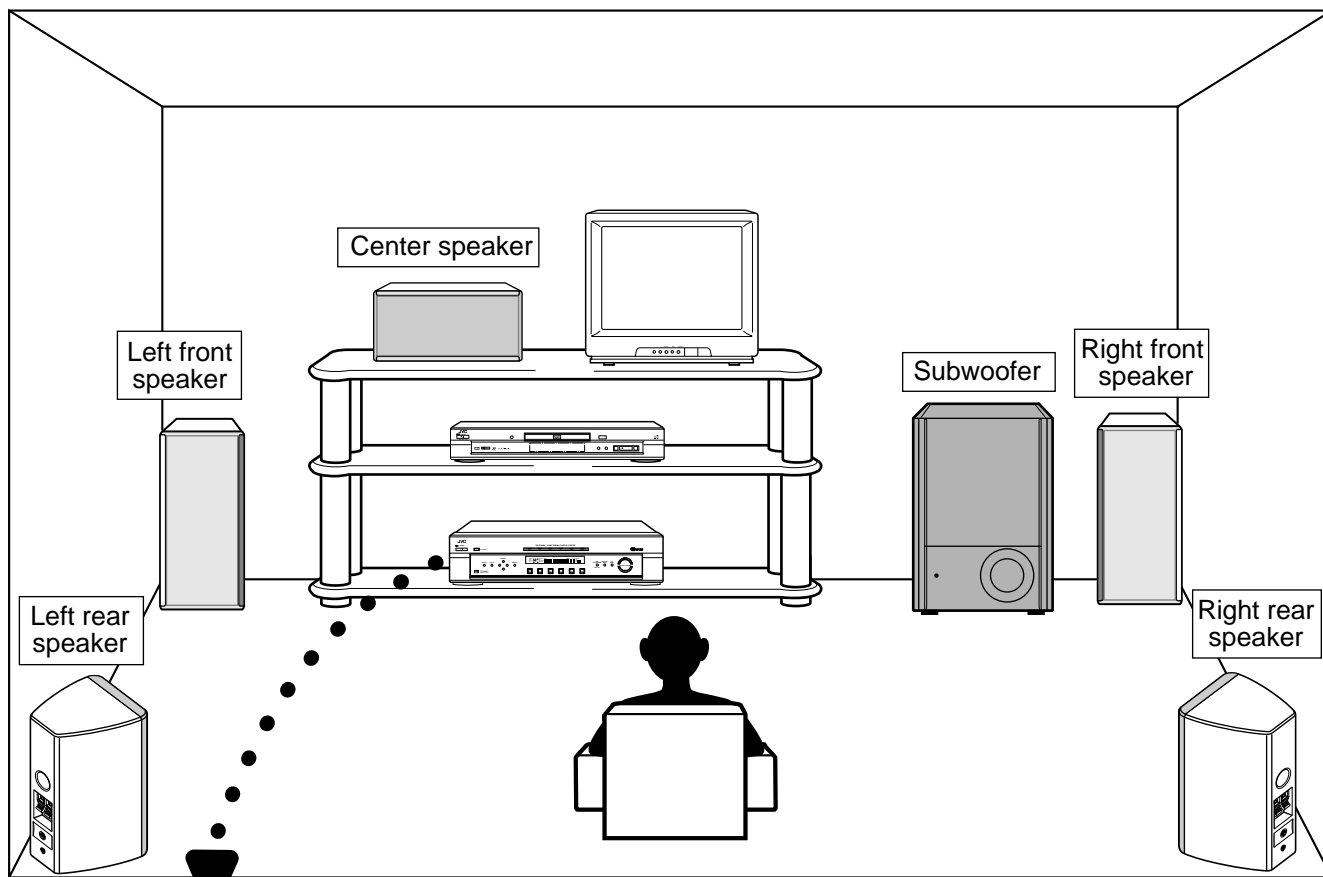

Connecting Audio/Video Components

Turn the power off to all components before connections.

Connecting cords are not supplied with this unit. Use the cords supplied for the other components or purchase them at an audio or electric appliance store.

A Coaxial digital cord

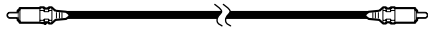

B Optical digital cord

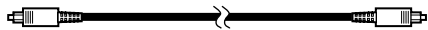

C Audio cord

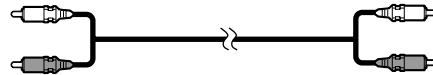

D SCART cable

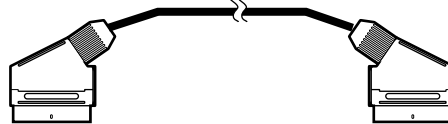

Digital connections

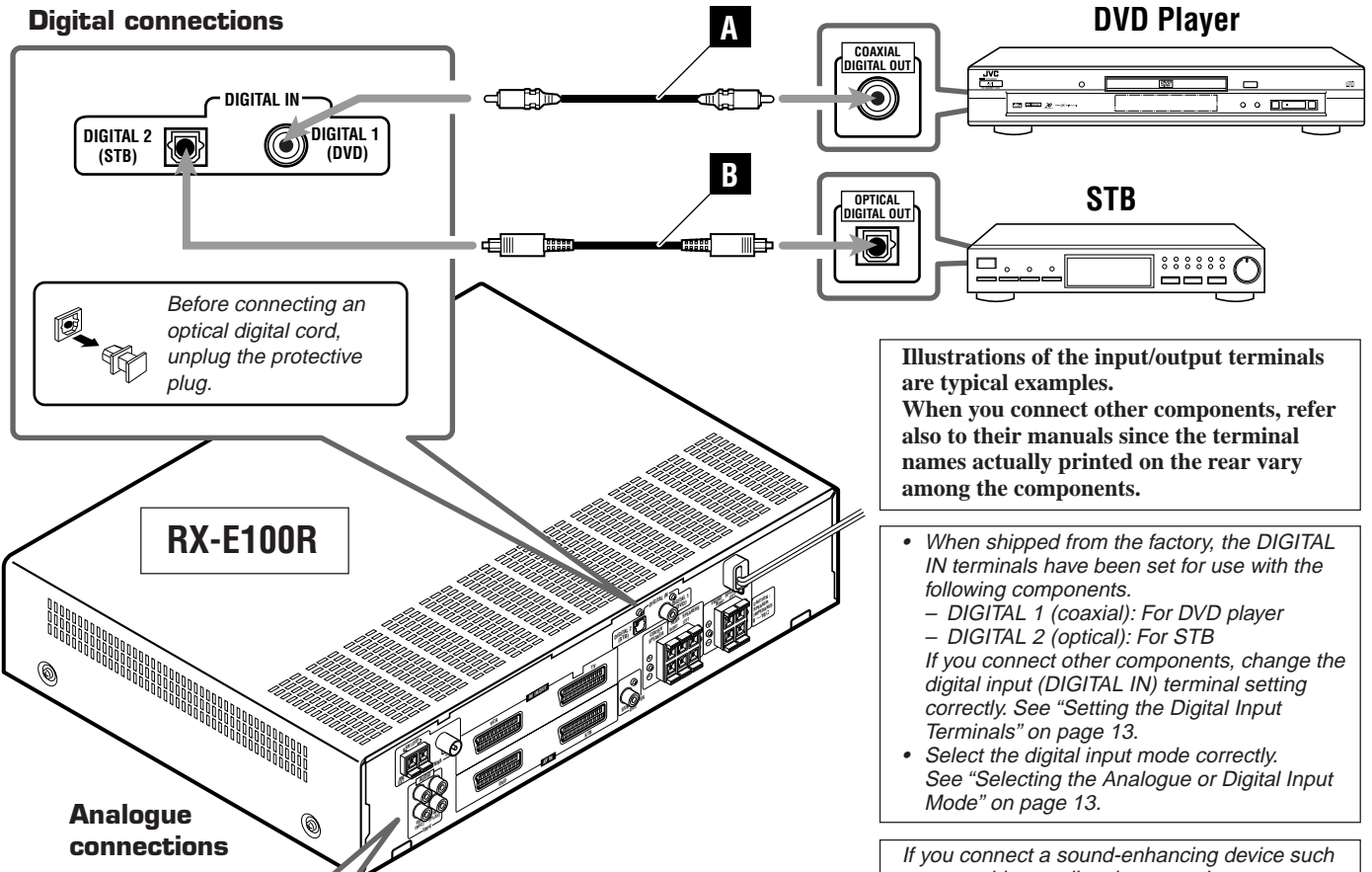

Illustrations of the input/output terminals are typical examples. When you connect other components, refer also to their manuals since the terminal names actually printed on the rear vary among the components.

- When shipped from the factory, the DIGITAL IN terminals have been set for use with the following components.
 - DIGITAL 1 (coaxial): For DVD player
 - DIGITAL 2 (optical): For STB
 If you connect other components, change the digital input (DIGITAL IN) terminal setting correctly. See "Setting the Digital Input Terminals" on page 13.
- Select the digital input mode correctly. See "Selecting the Analogue or Digital Input Mode" on page 13.

If you connect a sound-enhancing device such as a graphic equalizer between the source components and this unit, the sound output through this unit may be distorted.

Analogue connections

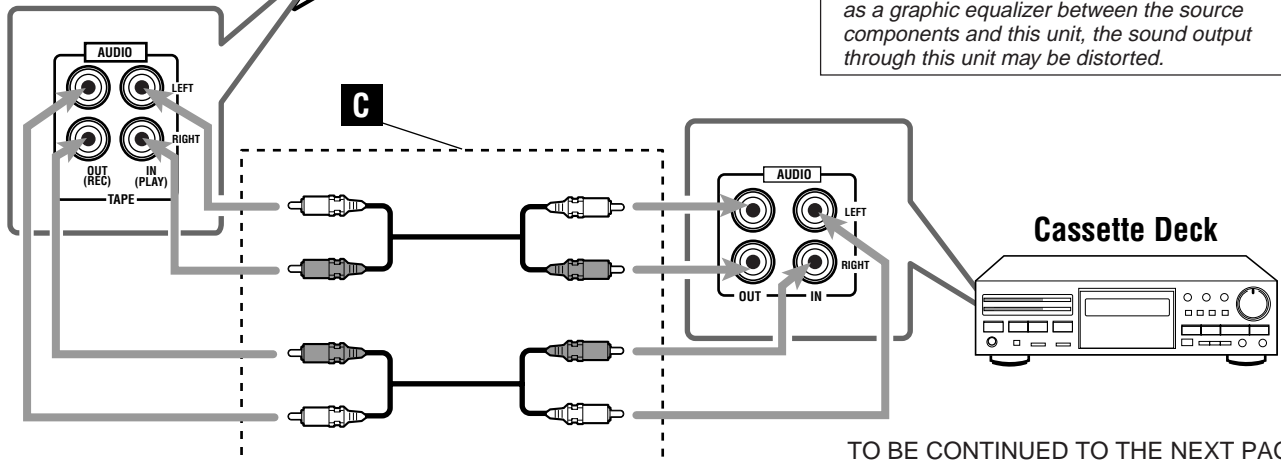

TO BE CONTINUED TO THE NEXT PAGE

Getting Started

Turn the power off to all components before connections.

Illustrations of the input/output terminals below are typical examples. When you connect other components, refer also to their manuals since the terminal names actually printed on the rear vary among the components.

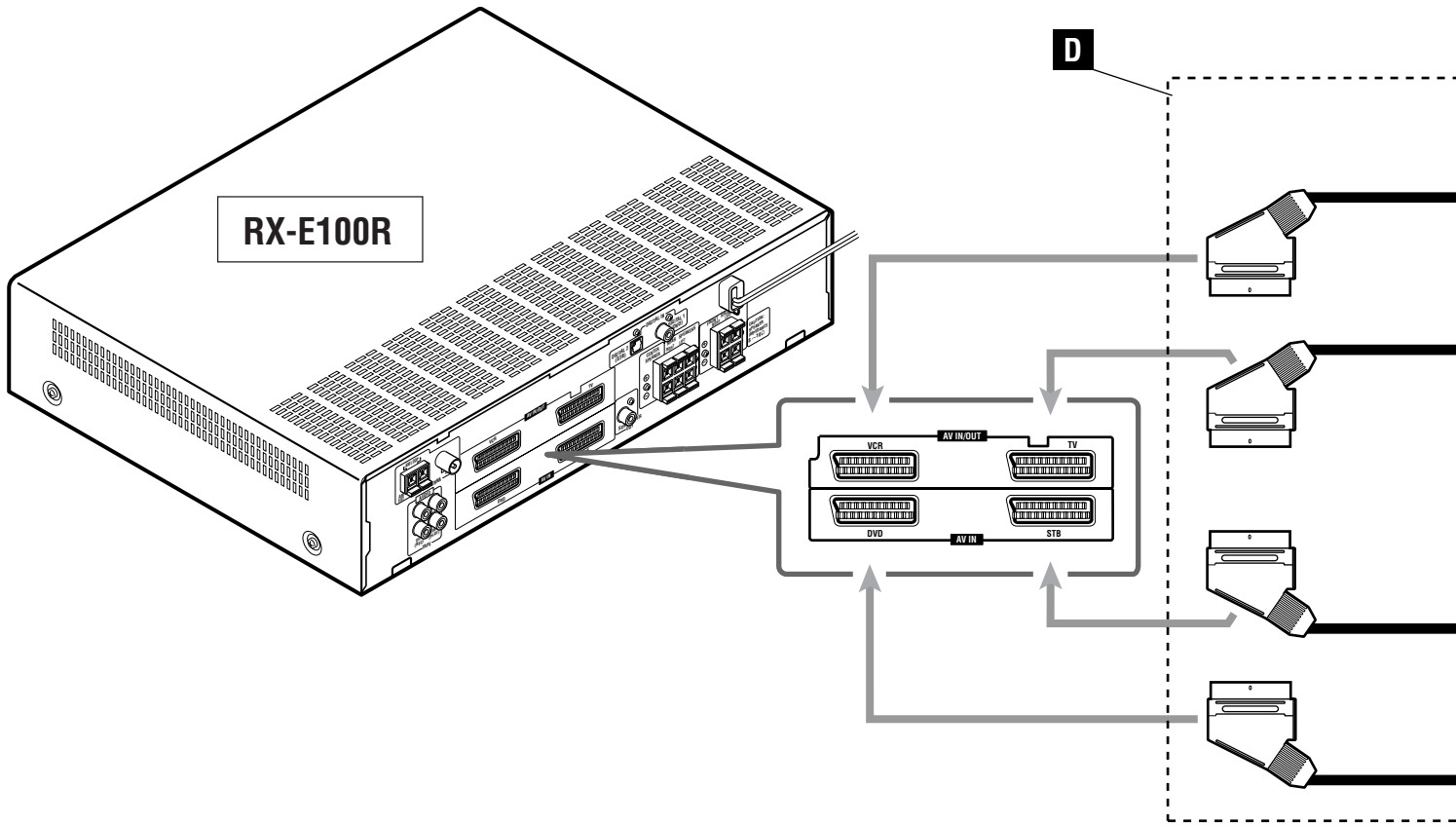

SCART Terminal Specifications

			TV	VCR	STB	DVD
IN	AUDIO	L/R	○	○	○	○
	VIDEO	Composite	○	○	○	○
		S-VIDEO	—	○	○	○
		RGB	—	○	○	
OUT	AUDIO	L/R	○*1	○*1	/	
	VIDEO	Composite	○*1*2	○*1*2		
		S-VIDEO	○*2	—		
	RGB	○*2	—			
T-V LINK			○*3	○*3		

- *1 The signals input from a SCART terminal cannot be output through the same SCART terminal.
- *2 The video format of the output video signals are consistent with that of the input video signals. For example, if S-VIDEO signals are input to this unit, no signals other than S-VIDEO signals can be output from this unit. Refer to the manuals supplied with the video components to check the setting of the input/output video signals.
- *3 The signals for T-V LINK function are always going through the unit.

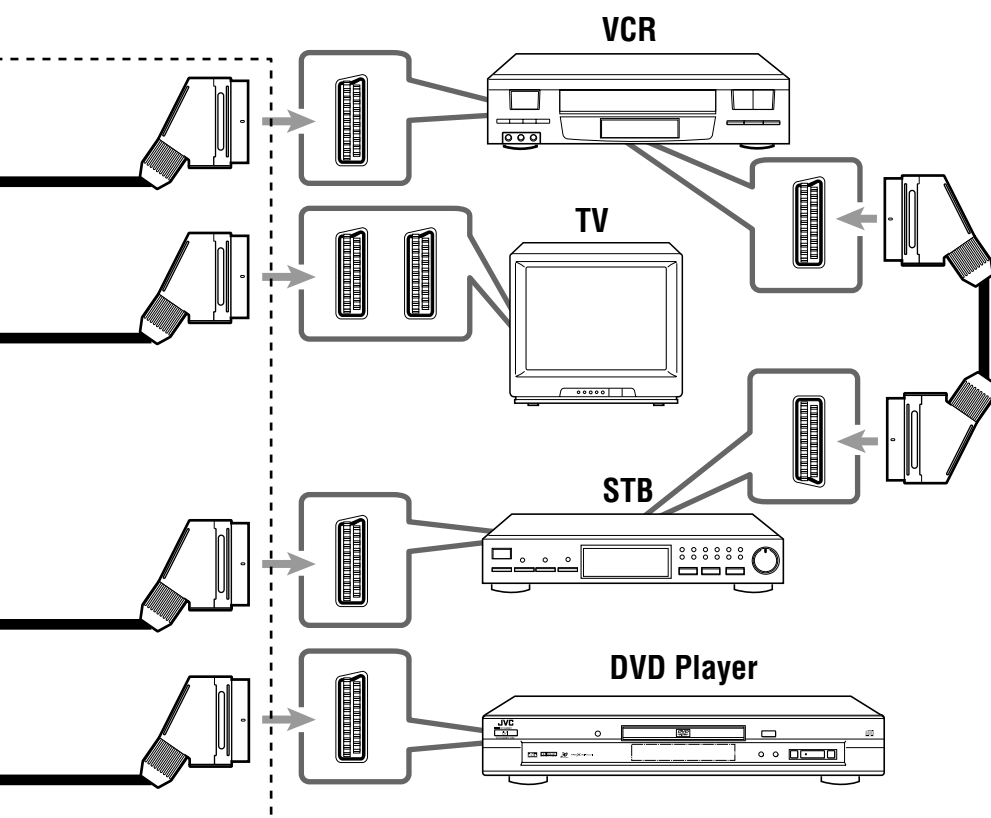

For digital sounds

- To enjoy the DVD software encoded with Dolby Digital or DTS Digital Surround, connect the DVD player using one of the DIGITAL IN terminals (see page 7).
- To enjoy the digital sounds, use both the SCART cable connection and the digital connection (see page 7).
- To enjoy the digital broadcast sounds, connect the STB and/or TV to the DIGITAL IN terminals (see page 7).

For T-V LINK

- You can also use T-V LINK function if you connect the T-V LINK compatible TV and VCR to this unit with a fully wired SCART cables. For details on T-V LINK, see the manuals supplied with the TV and the VCR.
- Connect SCART cable to EXT-2 terminal on your TV for T-V LINK function.

For recording pictures from STB

When you connect a STB and a VCR directly with a SCART cable, you can enjoy recording the pictures from the STB on VCR tapes without menu screens of STB. For details, see the manuals supplied with the STB.

For an analogue decoder

To watch or record a scrambled program on your VCR, connect the analogue decoder to your VCR, and select the scrambled channel on your VCR.

If there is not an appropriate terminal for the decoder on your VCR, connect the decoder to the TV.

Refer also to the manuals supplied with these equipment.

For TV and video format

When the TV is equipped with the plural SCART terminals, see the manual supplied with the TV to check the available video signals for each terminal, then connect SCART cable correctly. For details, see the manuals supplied with the TV.

This unit cannot change the video signals (S-video or Composite). When the video signal of one video component is different from that of the other (for example, one is S-video, the other is Composite), you may not see the pictures appropriately. In this case, unify the video signals of all the video components into S-video or Composite, or you need to switch the video signal of TV each time you change the source.

Connecting the Power Cord

Before plugging the unit into an AC outlet, make sure that all connections have been made.

Plug the power cord into an AC outlet.

Basic Operations

This manual mainly explains operations using the buttons and controls on the front panel. You can also use the buttons on the remote control if they have the similar names (or marks) as those on the front panel.

If operations using the remote control are different from those using the front panel, they are then explained.

- You can also see "Mastering Remote Operations" on page 40.

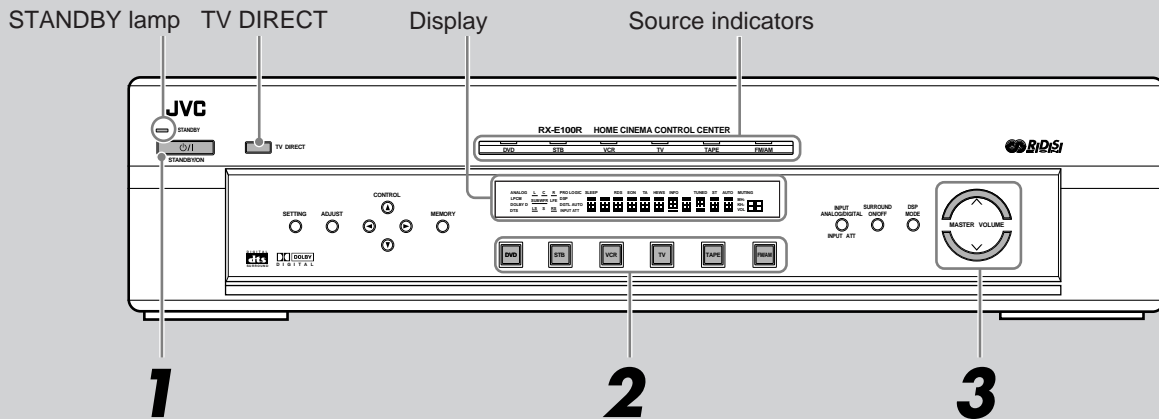

1 Turn On the Power

Press (or AUDIO | button on the remote control).

The STANDBY lamp goes off. The current source indicator lights green. The name of the current source (or station frequency) appears on the display.

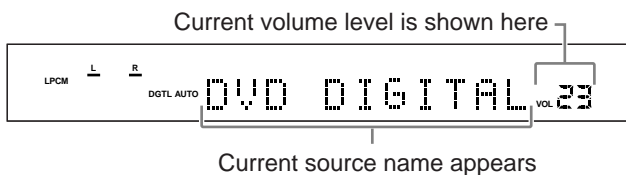
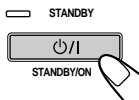

Note:

When you have connected some digital source components using the digital terminals (see page 7), see "Basic Settings" on pages 13, 14, and 15 to finish the digital input terminal setting and digital input mode setting correctly before use.

3 Adjust the Volume

To increase the volume, press and hold MASTER VOLUME (or VOLUME + on the remote control).

To decrease the volume, press and hold MASTER VOLUME (or VOLUME - on the remote control).

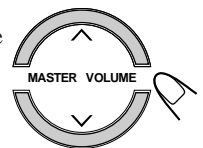

To turn off the power (into standby)

Press (or AUDIO) again.

The STANDBY lamp lights up.

A small amount of power is consumed in standby mode. To turn the power off completely, unplug the AC power cord.

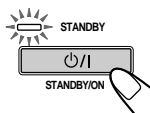

CAUTION:

Always set the volume to the minimum before starting any source. If the volume is set at its high level, the sudden blast of sound energy can permanently damage your hearing and/or ruin your speakers.

Notes:

- The volume level can be adjusted within the range of "0" (minimum) to "70" (maximum).
- Each time you press the button, the volume level changes by 2 steps from "0" (minimum) to "14" and by 1 step from "14" to "70" (maximum).

2 Select the Source to Play

Press one of the source selecting buttons.



- DVD : Select the DVD player.
- STB : Select STB.
- VCR : Select the VCR.
- TV : Select the TV tuner.
- TAPE : Select the cassette recorder.
- FM/AM : Select an FM or AM broadcast.

The selected source indicator lights green.

Activating TV Direct

TV Direct is enable you to use this unit as an AV selector while the unit is not turned on.

When TV Direct is activated, the pictures and sounds go from the video components such as DVD player to the TV through this unit. In this case, you can use the video components and the TV as if you connect them directly.

- This function takes effect only when the video components and TV are connected to this unit with SCART cables.
- This function takes effect to the following sources — DVD, STB, and VCR.
- This unit can be automatically turned on or off, and/or select the source automatically when you set the TV Direct mode to “AUTO 1” or “AUTO 2.” For details, see “Setting the TV Direct mode” on page 19.

To activate (or deactivate) TV Direct, follow the procedure below.

1 Press TV DIRECT.

All the indications disappear, then the source indicator currently selected lights red.



2 Turning on the video component and TV.

3 Press one of the source selecting buttons — DVD, STB, or VCR.

The indicator corresponding to the selected source lights red.

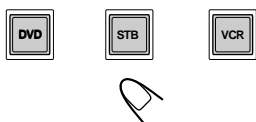

To cancel TV Direct and turn off the unit, press $\odot/|$ (or AUDIO \odot on the remote control).

The unit is turned off and the STANDBY lamp lights up.

To cancel TV Direct and turn on the unit, press TV DIRECT on the unit (or AUDIO | on the remote control).

The unit is turned on and the source indicator currently selected lights green.

Notes:

- When TV Direct is activated, you cannot enjoy all the sound effects this unit produces, and use the speakers connected to this unit.
- You can use T-V LINK function between TV and VCR while the TV Direct is activated.

Basic adjustment auto memory

This unit memorizes sound settings for each source

- when you turn on the power,
- when you change the source, and
- when you change the analogue/digital input mode (see page 14).

When you change the source, the memorized settings for the newly selected source are automatically recalled.

The following can be stored for each source:

- Analogue/digital input mode (see page 14)
- Input attenuator mode (see page 20)
- Balance (see page 20)
- Bass boost (see page 21)
- Tone adjustment (see page 21)
- Subwoofer output level (see page 22)
- Surround mode settings (see pages 33, 37)
 - Theatre Surround settings (see pages 35, 38)
 - DAP mode settings (see pages 36, 39)

Note:

If the source is FM or AM, you can assign a different setting for each band.

For recording

You can record sounds of any source playing through the unit to the VCR or the cassette deck.

While recording, you can listen to the selected sound source at whatever sound level you like without affecting the sound levels of the recording.

Note:

Sound adjustments (see page 20) and DSP modes (see page 32) cannot affect the recording.

Signal and speaker indicators on the display

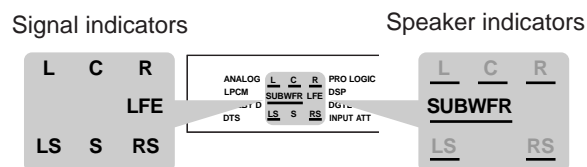

The following signal indicators light up —:

- L: • **When digital input is selected:** Lights up when the left channel signal comes in.
- **When analog input is selected:** Always lights up.
- R: • **When digital input is selected:** Lights up when the right channel signal comes in.
- **When analog input is selected:** Always lights up.
- C : Lights up when the center channel signal comes in.
- LS : Lights up when the left rear channel signal comes in.
- RS : Lights up when the right rear channel signal comes in.
- S : Lights up when the monaural rear channel signal comes in.
- LFE: Lights up when the LFE channel signal comes in.

The speaker indicators light up as follows:

- The subwoofer speaker indicator (**SUBWFR**) lights up when “SUBWFR” is set to “YES” (see page 15).
- The other speaker indicators light up only when the corresponding speaker is activated AND when the corresponding speaker is required for the DSP mode currently selected.

Basic Operations

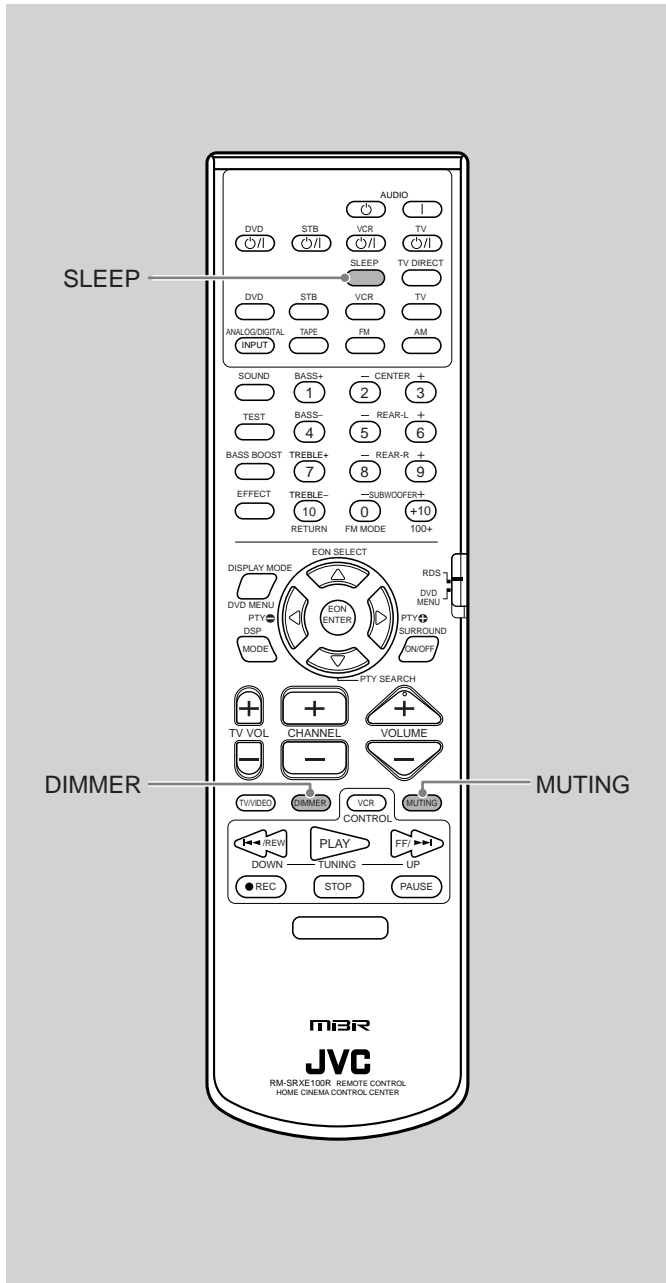

Turning Off the Power with the Timer

You can fall asleep while listening to music — Sleep Timer.

Press **SLEEP on the remote control** repeatedly. The SLEEP indicator lights up on the display, and the shut-off time changes in 10 minute intervals.

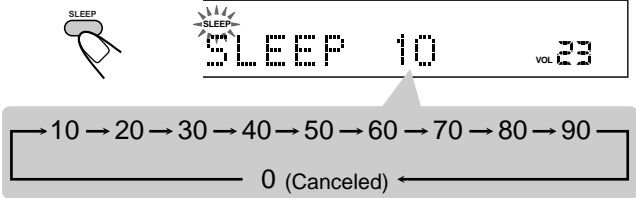

When the shut-off time comes
The unit turns off automatically.

To check or change the time remaining until the shut-off time
Press SLEEP once.
The remaining time (in minutes) until the shut-off time appears.

- To change the shut-off time, press SLEEP repeatedly.

To cancel the Sleep Timer
Press SLEEP repeatedly until “SLEEP 0” appears on the display. (The SLEEP indicator goes off.)

- Turning off the power also cancels the Sleep Timer.

Changing the Display Brightness

You can dim the display.

Press **DIMMER on the remote control**.

- Each time you press the button, the display dims and brightens alternately.



Turning Off the Sounds Temporarily

Press **MUTING on the remote control** to mute the sound through all speakers connected.



“MUTING” appears on the display and the volume turns off (the volume level indicator goes off).

To restore the sound, press MUTING again so that “MUTING OFF” appears on the display.

- Pressing MASTER VOLUME ^/∨ (or VOLUME +/-) also restores the sound.

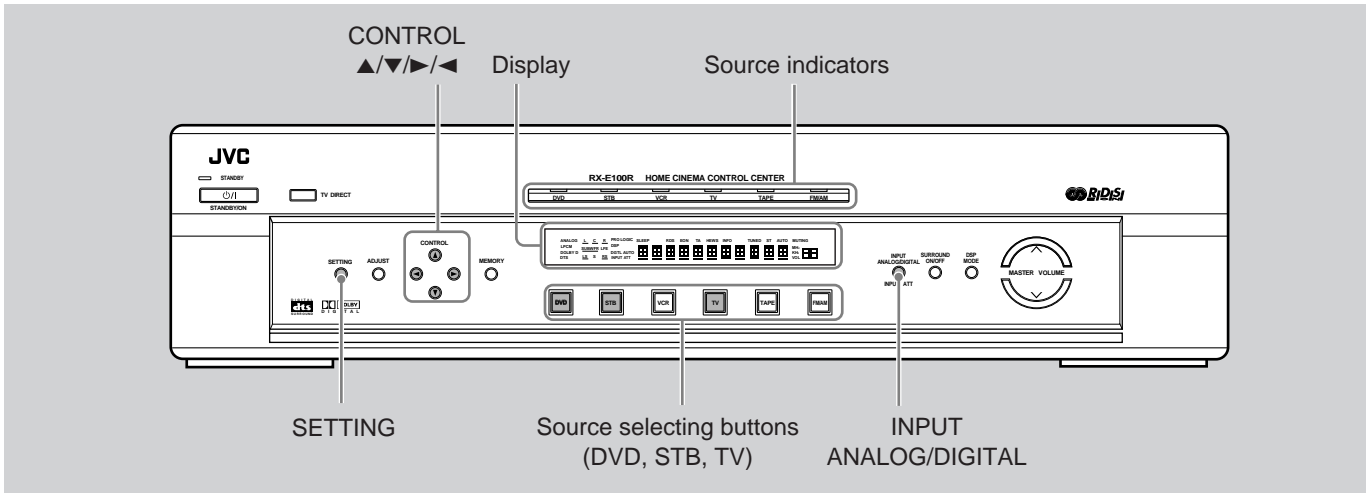

Setting the Digital Input Terminals



When you use the digital input terminals, register what components are connected to which terminals (DIGITAL IN 1/2) so that the correct source name will appear when you select the digital source.

Before you start, remember...

There is a time limit in doing the following steps. If the setting is canceled before you finish, start from step 1 again.

1 Press SETTING.



The CONTROL buttons now work for basic settings.

2 Press CONTROL ▼ (or ▲) repeatedly until "DGT (Digital)" (with the current setting)* appears on the display.



DGT 1DVD2STB VOL 23

* "1DVD2STB" is the initial setting. If you have already changed setting, another combination will be shown.

3 Press CONTROL ► (or ◀) to select the appropriate digital terminal setting.

- Each time you press the button, the display changes to show the following:

CONTROL



DGT 1DVD2STB VOL 23

DGT1DVD2STB	↔	DGT1DVD 2TV	↔
DGT1STB2DVD	↔	DGT1STB 2TV	↔
DGT1TV 2DVD	↔	DGT1TV 2STB	↔

(back to the beginning)

Note:

When shipped from the factory, the DIGITAL IN terminals have been set for use with the following components.

- DIGITAL 1 (coaxial): For DVD player
- DIGITAL 2 (optical): For STB

Selecting the Analogue or Digital Input Mode

When you have connected digital source components using both the analogue connection and the digital connection methods (see page 7), you need to select the input mode correctly.

1 Press one of the source selecting buttons (DVD, STB, or TV)* for which you want to change the input mode.



Note:

* Among the sources listed above, you can select the digital input only for the sources which you have selected the digital input terminals for. (See "Setting the Digital Input Terminals".)

2 Press INPUT ANALOG/DIGITAL (or ANALOG/DIGITAL INPUT on the remote control) to select the analogue or digital input mode.

- Each time you press the button, the input mode alternates between the analogue input (ANALOGUE) and the digital input (DGTL AUTO).



DGTL AUTO ↔ ANALOGUE

TO BE CONTINUED TO THE NEXT PAGE

Basic Settings

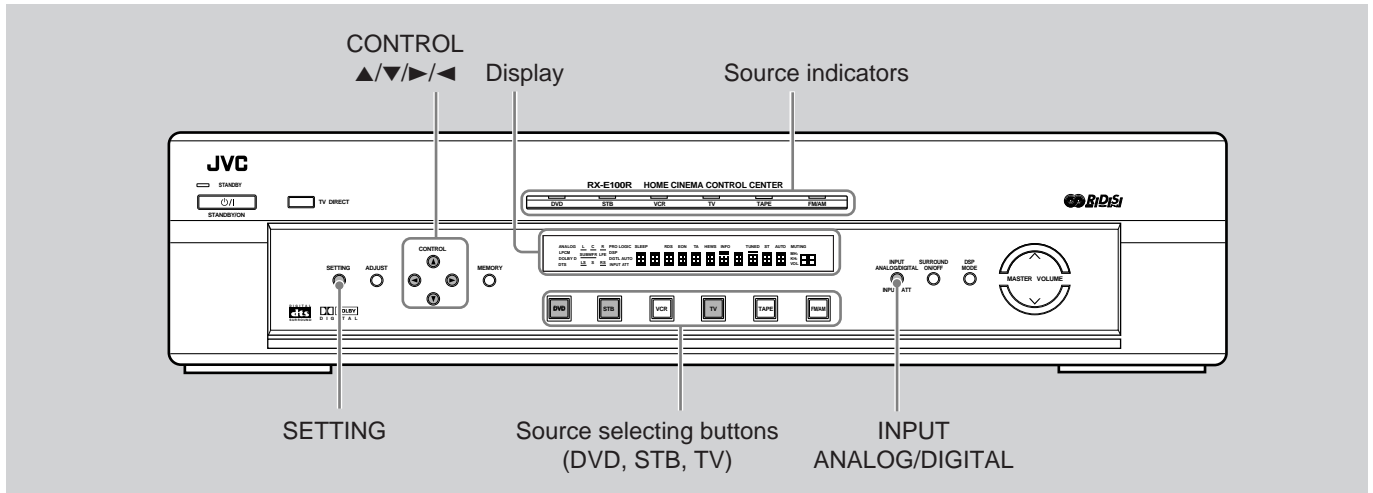

DGTL AUTO : Select this for the digital input mode. The unit automatically detects the incoming signal format. (The DGTL AUTO indicator lights up on the display, then the digital signal indicator for the detected signals lights up.)

ANALOGUE : Select this for the analogue input mode. (Initial setting when shipped from the factory.)

- To play back software encoded with Dolby Digital, select “DGTL D.D.”
- To play back software encoded with DTS Digital Surround, select “DGTL DTS.”

Note:

When you turn off the power or select another source, “DGTL DTS” and “DGTL D.D.” are canceled and the digital input mode is automatically reset to “DGTL AUTO.”

If the following symptoms occur while playing Dolby Digital or DTS Digital Surround software with “DGTL AUTO” selected, follow the procedure below.

- Sound does not come out at the beginning of playback.
- Noise comes out while searching or skipping chapters or tracks.

1 Press one of the source selecting buttons (DVD, STB, or TV) for which you want to change the input mode.

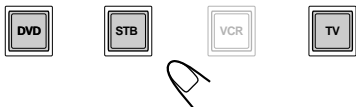

2 Press INPUT ANALOG/DIGITAL (or ANALOG/DIGITAL INPUT) to select the digital input mode (DGTL AUTO).



3 Press CONTROL ▶ (or ◀) to select “DGTL D.D.” or “DGTL DTS” while “DGTL AUTO” still remains on the display.



- Each time you press the button, the digital input mode changes as follows:

When “DGTL D.D.” or “DGTL DTS” is selected, “AUTO” goes off.

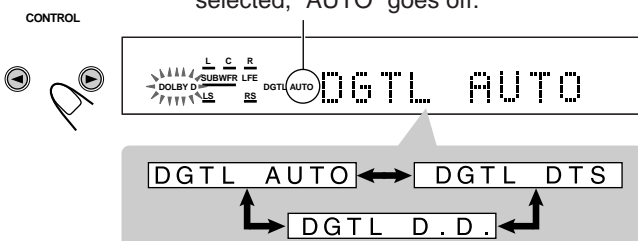

The following are the analogue/digital signal indicators on the display to indicate what type of the signal comes into the unit.

- ANALOGUE** : Lights when the analogue input is selected.
- LPCM** : Lights when Linear PCM signals come in.
- DOLBY D** : • Lights when Dolby Digital signals come in.
• Flashes when “DGTL D.D.” is selected for software not encoded with Dolby Digital.
- DTS** : • Lights when DTS Digital Surround signals come in.
• Flashes when “DGTL DTS” is selected for software not encoded with DTS Digital Surround.

Note:

When “DGTL AUTO” cannot recognize the incoming signals, no digital signal indicators light up on the display.

Setting the Subwoofer Information



When you have connected a subwoofer, follow the procedure below. If you do not use a subwoofer, you can skip this setting.

Before you start, remember...

There is a time limit in doing the following steps. If the setting is canceled before you finish, start from step 1 again.

1 Press SETTING.



The CONTROL buttons now work for basic settings.

2 Press CONTROL ▼ (or ▲) repeatedly until “SUBWFR (Subwoofer)” (with the current setting)* appears on the display.



SUBWFR : NO VOL.23

* “NO” is the initial setting. If you have already changed the setting, “YES” will be shown.

3 Press CONTROL ► (or ◀) to select “YES.”

- Each time you press the button, the subwoofer setting alternates between “YES” and “NO.”

CONTROL



SUBWFR : NO VOL.23

SUBWFR : NO ↔ SUBWFR : YES

YES	: Select this when a subwoofer is used. The subwoofer speaker indicator (SUBWFR) lights up on the display (see page 11). You can adjust the subwoofer output level (see page 22).
NO	: Select this when you have not connected or have disconnected a subwoofer.

Setting the Speakers for DSP Modes



To obtain the best possible surround effect from the DSP (Digital Signal Processor) modes (see page 32), register the following information after all connections are completed.

- Speaker Size — FR SP, CTR SP, REAR SP
- Delay Time — CTR DL, REAR DL
- Crossover Frequency — CROSS
- Dynamic Range Compression — D.R.C.
- Low Frequency Effect Attenuator — LFE

Speaker Size — FR SP, CTR SP, REAR SP

Register the sizes of all the connected speakers.

- When you change your speakers, register the information about the speakers again.

Before you start, remember...

There is a time limit in doing the following steps. If the setting is canceled before you finish, start from step 1 again.

1 Press SETTING.



The CONTROL buttons now work for basic settings.

2 Press CONTROL ▼ (or ▲) repeatedly until one of the following speakers (with the current setting)* appears.



FR SP : LRG VOL.23

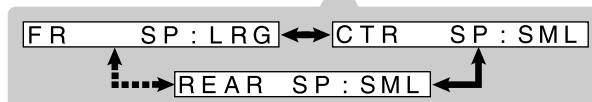

FR SP (Front Speaker) : To register the front speaker size.

CTR SP (Center Speaker) : To register the center speaker size.

REAR SP (Rear Speaker) : To register the rear speaker size.

* “LRG (large)” is the initial setting for the front speakers, and “SML (small)” is for the center and rear speakers. If you have already changed the setting, another size will be shown.

3 Press CONTROL ► (or ◀) to select the appropriate speaker size.

- Each time you press the button, the speaker size changes as follows:

CONTROL



REAR SP : SML VOL.23

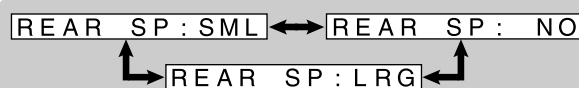

Ex.: When registering the rear speaker size

LRG (Large) : Select this when the speaker size is relatively large. (See “Notes” below.)

SML (Small) : Select this when the speaker size is relatively small. (See “Notes” below.)

NO : Select this when you have not connected a speaker. (Not selectable for the front speakers.)

4 Repeat steps 2 and 3 to select the appropriate size for the other speakers.

Notes:

- Use the following criteria as reference when adjusting:
 - If the size of the cone speaker unit built in your speaker is greater than 4 3/4 inches (12 cm), select “LRG (large),” and if it is smaller than 4 3/4 inches (12 cm), select “SML (small).”
- If you have selected “NO” for the subwoofer, you can only select “LRG (large)” for the front speaker size.
- If you have selected “SML (small)” for the front speaker size, you cannot select “LRG (large)” for the center and rear speaker sizes.

Basic Settings

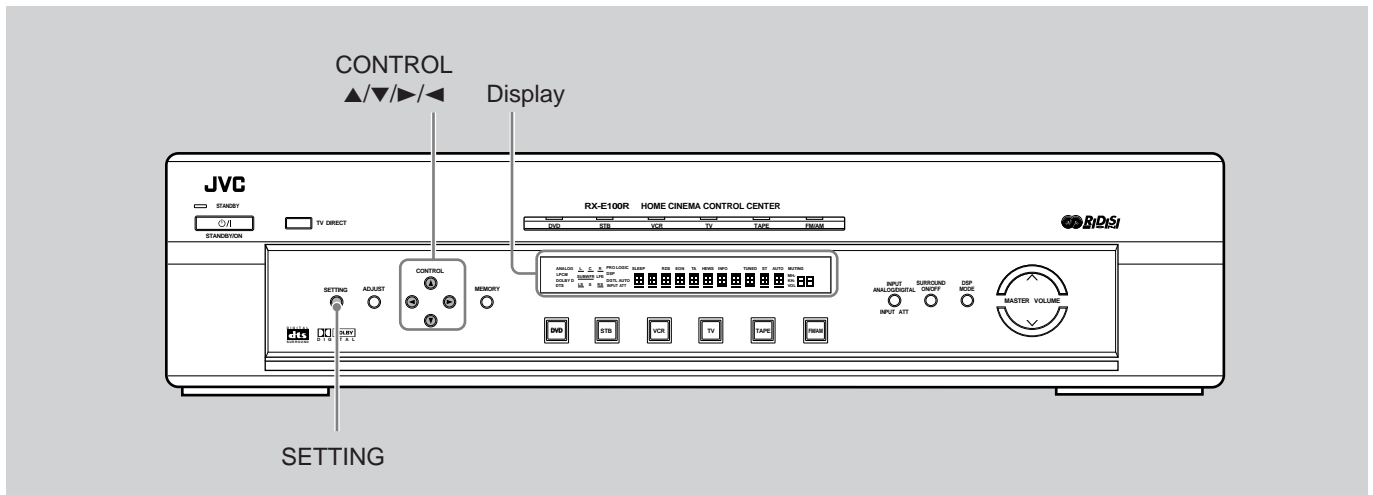

Delay Time — CTR DL, REAR DL

Adjust the delay time of the sounds from the center speaker and from the rear speakers, comparing to that of the sound from the front speakers. If the distance to the center speaker and/or the rear speakers from your listening point is almost the same as that to the front speakers, select 0 msec.

- 1 msec increase (or decrease) in delay time corresponds to 11^{13/16} inch (30 cm) increase (or decrease) in distance.

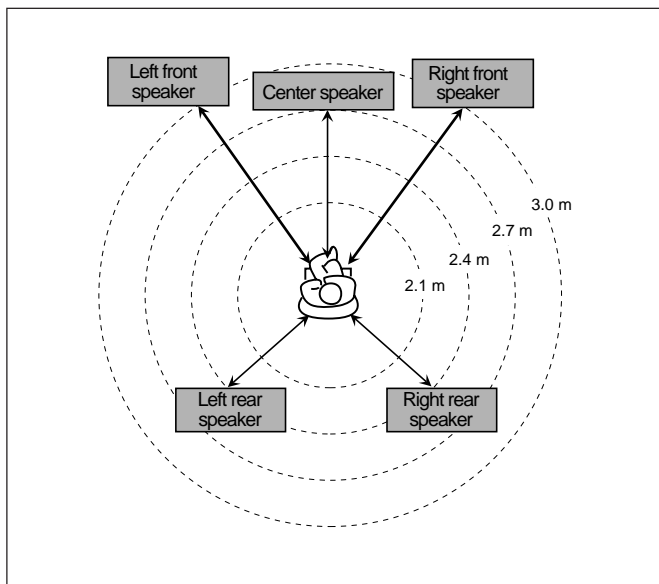

Ex.: In this case, set the center delay to “1 mS” and the rear delay to “2 mS.”

Before you start, remember...

There is a time limit in doing the following steps. If the setting is canceled before you finish, start from step 1 again.

1 Press SETTING.



The CONTROL buttons now work for basic settings.

2 Press CONTROL ▼ (or ▲) repeatedly until “CTR DL (Center Delay)” or “REAR DL (Rear Delay)” (with the current setting)* appears on the display.

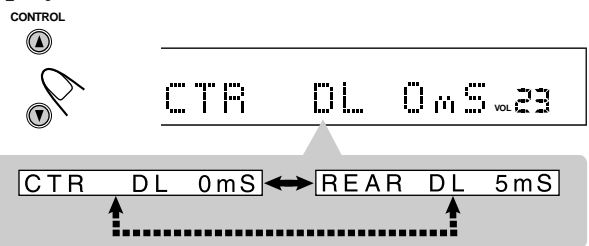

CTR DL (Center Delay) : To adjust the center delay time (from 0 msec to 5 msec).

REAR DL (Rear Delay) : To adjust the rear delay time (from 0 msec to 15 msec).

* “0 mS” is the initial setting for the center delay time and “5 mS” for the rear delay time. If you have already changed the setting, another setting will be shown.

3 Press CONTROL ▶ (or ◀) to select the delay time.

- Each time you press the button, the delay time changes by 1 msec (mS).

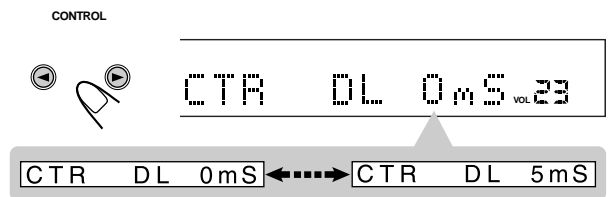

Ex.: When adjusting the center delay

4 Repeat steps 2 and 3 to adjust the other delay time.

Crossover Frequency — CROSS

Small speakers cannot reproduce the bass sounds efficiently. If you use a small speaker in any position, this unit automatically reallocates the bass sound elements assigned to the small speaker to the large speakers.

To use this function properly, set this crossover frequency level according to the size of the small speaker connected.

- If you have selected “LRG (large)” for all speakers, this function will not take effect.

Before you start, remember...

There is a time limit in doing the following steps. If the setting is canceled before you finish, start from step 1 again.

1 Press SETTING.

SETTING



The CONTROL buttons now work for basic settings.

2 Press CONTROL ▼ (or ▲) repeatedly until “CROSS (Crossover)” (with the current setting)* appears on the display.

CONTROL



CROSS : 100HZ VOL. 23

- * “100HZ” is the initial setting. If you have already changed the setting, another frequency will be shown.

3 Press CONTROL ► (or ◀) to select the crossover frequency level.

- Each time you press the button, the crossover frequency level changes as follows:

CONTROL



CROSS : 100HZ VOL. 23

CROSS : 100HZ ↔ CROSS : 120HZ

↕
CROSS : 80HZ

- Use the following criteria as reference when adjusting:

80HZ : Select this frequency when the cone speaker unit built in the speaker is about 4 ³/₄ inches (12 cm).

100HZ : Select this frequency when the cone speaker unit built in the speaker is about 3 ¹⁵/₁₆ inches (10 cm).

120HZ : Select this frequency when the cone speaker unit built in the speaker is about 3 ³/₁₆ inches (8 cm).

Dynamic Range Compression — D.R.C.

You can compress the dynamic range (difference between maximum sound and minimum sound) of the reproduced sound. This is useful when enjoying surround sound at night.

- This function takes effect only when playing back a source using Dolby Digital.

Before you start, remember...

There is a time limit in doing the following steps. If the setting is canceled before you finish, start from step 1 again.

1 Press SETTING.

SETTING



The CONTROL buttons now work for basic settings.

2 Press CONTROL ▼ (or ▲) repeatedly until “D.R.C. (Dynamic Range Compression)” (with the current setting)* appears on the display.

CONTROL



D.R.C. : MID VOL. 23

- * “MID” is the initial setting. If you have already changed the setting, another setting will be shown.

3 Press CONTROL ► (or ◀) to select the appropriate compression level.

- Each time you press the button, the compression level changes as follows:

CONTROL



D.R.C. : MID VOL. 23

D.R.C. : MID ↔ D.R.C. : MAX

↕
D.R.C. : OFF

OFF : Select this when you want to enjoy surround with its full dynamic range. (No effect applied.)

MID : Select this when you want to reduce the dynamic range a little.

MAX : Select this when you want to apply the compression effect fully. (Useful at night.)

Basic Settings

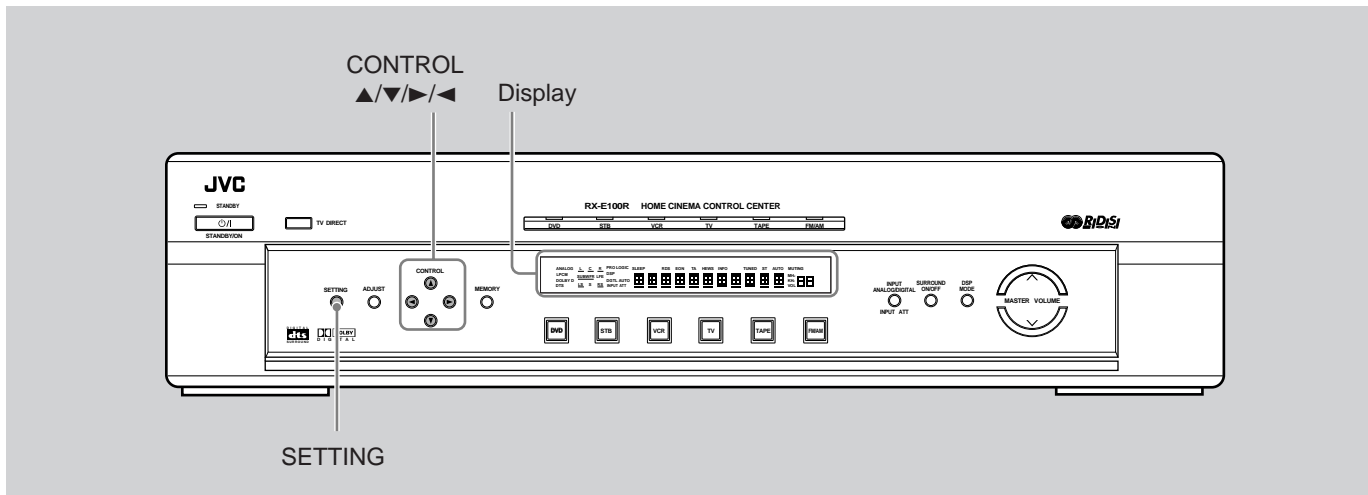

Low Frequency Effect Attenuator — LFE

If the bass sound is distorted while playing back software using Dolby Digital or DTS Digital Surround, follow the procedure below.

- This function takes effect only when the subwoofer (LFE) signals come in, (with “SUBWFR” set to “YES”).

Before you start, remember...

There is a time limit in doing the following steps. If the setting is canceled before you finish, start from step 1 again.

1 Press SETTING.



The CONTROL buttons now work for basic settings.

2 Press CONTROL ▼ (or ▲) repeatedly until “LFE (Low Frequency Effect)” (with the current setting)* appears on the display.

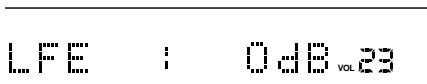

* “0” is the initial setting. If you have already changed the setting, “-10dB” will be shown.

3 Press CONTROL ► (or ◀) to select the LFE attenuator level.

- Each time you press the button, the LFE attenuator level changes as follows:

CONTROL

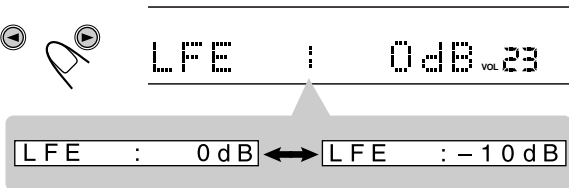

0dB : Normally select this.

-10dB : Select this when the bass sound is distorted.

Setting Auto Surround



Surround mode is automatically activated when a multichannel signal comes into this unit through the digital terminal. You can enjoy Surround mode simply by selecting the source (with digital input selected for that source) — Auto Surround.

To activate Auto Surround, follow the procedure below.

Before you start, remember...

There is a time limit in doing the following steps. If the setting is canceled before you finish, start from step 1 again.

1 Press SETTING.



The CONTROL buttons now work for basic settings.

2 Press CONTROL ▼ (or ▲) repeatedly until “AUTO SR (Auto Surround)” (with the current setting)* appears on the display.



* “OFF” is the initial setting. If you have already changed the setting, “ON” will be shown.

3 Press CONTROL ► (or ◀) to select “ON” (or “OFF”).

- Each time you press the button, Auto Surround turns “ON” or “OFF.”

CONTROL

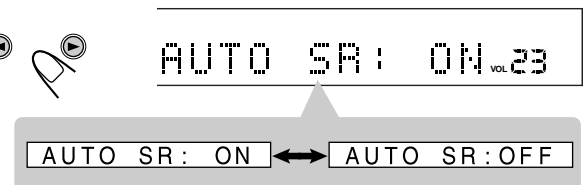

ON : • If multichannel signals come in, an appropriate Surround mode will be turned on.
• If Dolby Digital 2 channel or DTS 2 channel signals come in, "STEREO" will be selected.
• If Linear PCM signals come in, nothing will change.

OFF : Select this to deactivate Auto Surround.

Notes:

- This function does not take effect in the following cases:
 - While playing an analogue source.
 - While selecting "DGTL D.D." or "DGTL DTS" as the fixed digital input mode (see pages 13 and 14).
- If Surround mode is automatically activated by Auto Surround, another DSP mode in use will be canceled temporarily. When multichannel digital signals stop coming in, the selected surround mode is canceled, and the previous DSP mode resumes.
- If you press SURROUND ON/OFF or DSP MODE with Auto Surround activated, Auto Surround will be canceled temporarily for the currently selected source. Auto Surround setting will be restored in the following cases:
 - When you turn off and on the unit,
 - When you change the source, and
 - When you reset "AUTO SR" to "ON" again.

To cancel Auto Surround

Repeat steps 1 and 2, then select "OFF" in step 3.

Setting the TV Direct mode

You can enjoy switching TV Direct automatically by turning on/off the video components connected to the unit with SCART cable — TV Direct auto mode.

- This function takes effect only when the video components and TV are connected to this unit with SCART cables.
- This function takes effect to the following sources — DVD, STB, and VCR.

Before you start, remember...

There is a time limit in doing the following steps. If the setting is canceled before you finish, start from step 1 again.

1 Press SETTING.

SETTING



The CONTROL buttons now work for basic settings.

2 Press CONTROL ▼ (or ▲) repeatedly until "MODE" (with the current setting)* appears on the display.

CONTROL



MODE : MANUAL VOL. 23

* "MANUAL" is the initial setting. If you have already changed the setting, the other mode will be shown.

3 Press CONTROL ► (or ◀) to select "AUTO1" (or, "AUTO2" or "MANUAL").

- Each time you press the button, TV Direct mode turns change as follows:

CONTROL



MODE : AUTO 1 VOL. 23

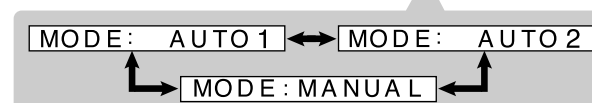

AUTO1 : When a video component is turned on while the unit is on, the unit selects the video component as the source automatically.

AUTO2 : • **When a video component is turned on**
– while the unit is off, the unit changes the mode into TV Direct and selects the video component as the source automatically.
– while the unit is on or TV Direct is activated, the unit selects the video component as the source automatically.
• **When a video component is turned off**
– while TV Direct is activated or the unit is on with one of the video components selected, the unit selects the previously selected video component as the source automatically. (If all the video components are turned off, the unit will be turned off automatically.)

MANUAL : Select this to use TV Direct manually.

Note:

When a VCR is selected as the source, AUTO1 or AUTO2 does not work by turning on the VCR but by starting playback.

Sound Adjustments

You can also use the remote control for some sound adjustments.

- When using the remote control, see also “Mastering Remote Operations” on page 40.

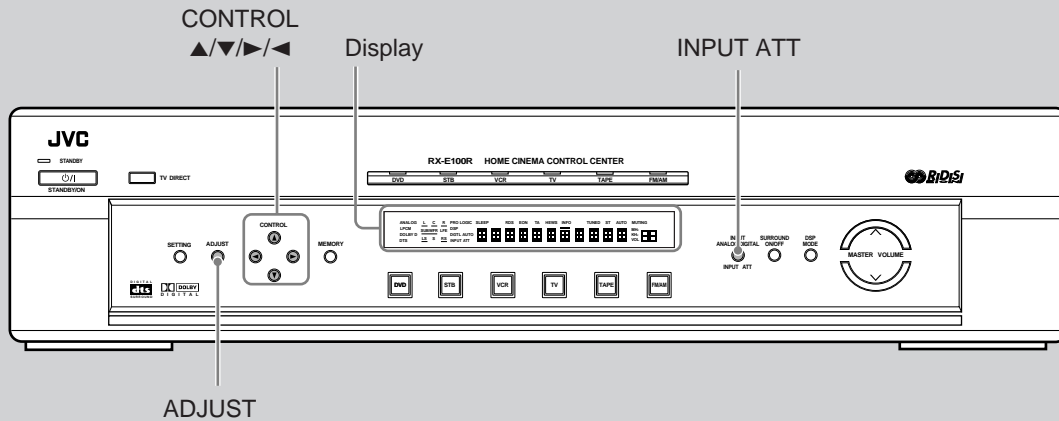

Attenuating the Input Signal



When the input level of the **analogue source** is too high, the sounds will be distorted. If this happens, you need to attenuate the input signal level to prevent the sound distortion.

- You have to make this adjustment for each **analogue source**.

Press and hold **INPUT ATT (INPUT ANALOG/DIGITAL)** so that the **INPUT ATT indicator lights up on the display**.

- Each time you press and hold the button, the Input Attenuator turns on (“ATT ON”) or off (“ATT NORMAL”).

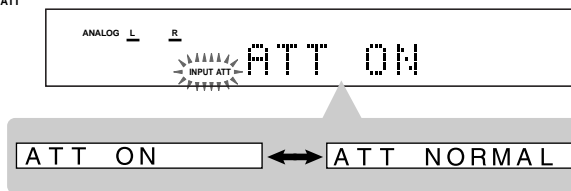

Adjusting the Front Speaker Output Balance



If the sounds you hear from the front right and left speakers are unequal, you can adjust the speaker output balance.

- You have to make this adjustment for each source.

Before you start, remember...

There is a time limit in doing the following steps. If the setting is canceled before you finish, start from step 1 again.

1 Press ADJUST.

ADJUST



The CONTROL buttons now work for sound adjustments.

2 Press CONTROL ▼ (or ▲) repeatedly until “BAL (Balance)” (with the current setting)* appears on the display.

CONTROL

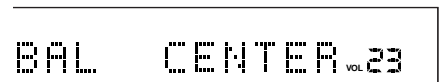

- * “CENTER” is the initial setting. If you have already changed the setting, another setting will be shown.

3 Press CONTROL ▶ or ◀ to adjust the front speaker balance.

CONTROL

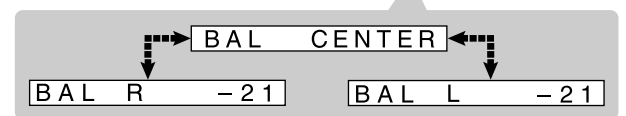

- Pressing CONTROL ▶ decreases the left channel output (from CENTER to L-21).
- Pressing CONTROL ◀ decreases the right channel output (from CENTER to R-21).

Reinforcing the Bass

You can boost the bass level — Bass Boost.

- You have to make this adjustment for each source.

Before you start, remember...

There is a time limit in doing the following steps. If the setting is canceled before you finish, start from step 1 again.

1 Press ADJUST.



The CONTROL buttons now work for sound adjustments.

2 Press CONTROL ▼ (or ▲) repeatedly until “B. BOOST (Bass Boost)” (with the current setting)* appears on the display.



B. BOOST OFF VOL. 23

* “OFF” is the initial setting. If you have already changed the setting, “ON” will be shown.

3 Press CONTROL ► (or ◀) to turn “ON” or “OFF” Bass Boost.

CONTROL



B. BOOST OFF VOL. 23

B. BOOST OFF ↔ B. BOOST ON

ON : Select this to boost the bass level. (Bass Boost)

OFF : Select this to deactivate Bass Boost.

Note:

This function affects the sound outputting only through the front speakers.

When using the remote control

Press BASS BOOST.

- Each time you press the button, Bass Boost turns on and off alternately.

Adjusting the Tone

You can adjust the bass and treble sounds as you like.

- You have to make these adjustments for each source.

Before you start, remember...

There is a time limit in doing the following steps. If the setting is canceled before you finish, start from step 1 again.

1 Press ADJUST.



The CONTROL buttons now work for sound adjustments.

2 Press CONTROL ▼ (or ▲) repeatedly until “BASS” or “TREBLE” (with the current setting)* appears.

CONTROL



BASS 0 VOL. 23

BASS 0 ↔ TREBLE 0

BASS : To adjust the bass.

TREBLE : To adjust the treble.

* “0” is the initial setting. If you have already changed the setting, another number (level) will be shown.

3 Press CONTROL ► or ◀ to adjust the sound level.

CONTROL



BASS 0 VOL. 23

BASS -10 ↔ BASS +10

Ex.: When adjusting the bass level

- Pressing CONTROL ► increases the sound level by +2 steps (from -10 to +10).
- Pressing CONTROL ◀ decreases the sound level by -2 steps (from +10 to -10).

4 Repeat steps 2 and 3 to adjust the other sound level.

When using the remote control

1 Press SOUND.

10 keys now work for sound adjustments.

2 Press BASS +/- or TREBLE +/- to adjust the sound output level (from -10 to +10).

Sound Adjustments

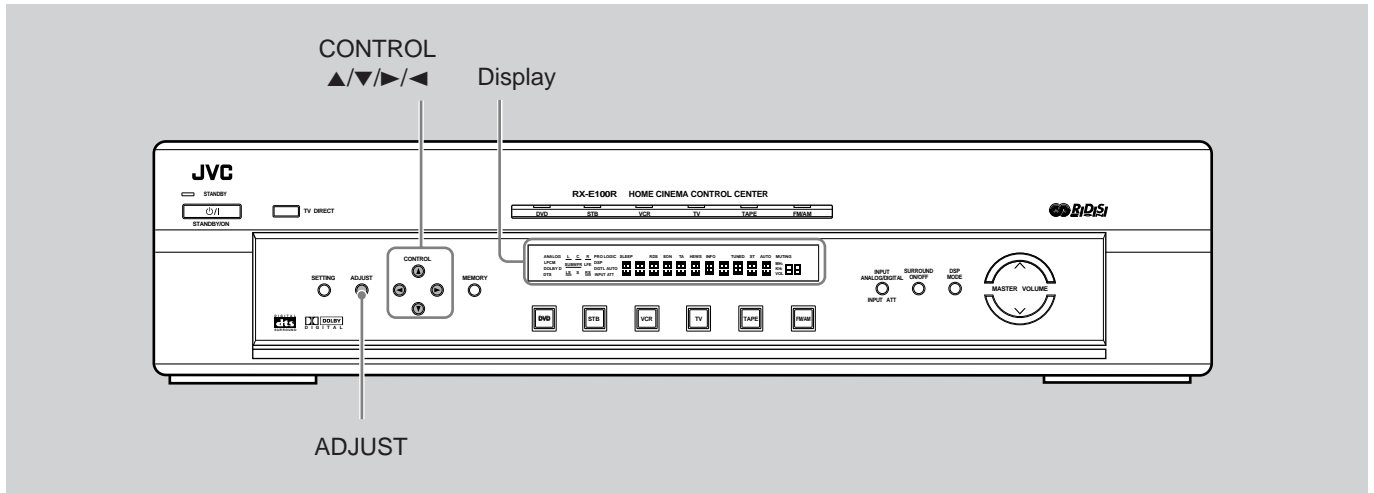

Adjusting the Subwoofer Output Level

You can adjust the subwoofer output level if you have connected a subwoofer and set the subwoofer information correctly – “YES.”

- You have to make this adjustment for each source.

Before you start, remember...

There is a time limit in doing the following steps. If the setting is canceled before you finish, start from step 1 again.

1 Press ADJUST.



The CONTROL buttons now work for sound adjustments.

2 Press CONTROL ▼ (or ▲) repeatedly until “SUBWFR (subwoofer)” (with the current setting)* appears.

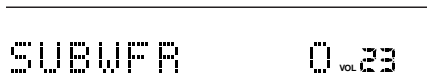

* “0” is the initial setting. If you have already changed the setting, another number (level) will be shown.

3 Press CONTROL ▶ or ◀ to adjust the sound output level.

CONTROL

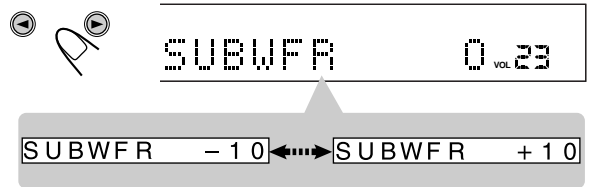

- Pressing CONTROL ▶ increases the sound output level (from –10 to +10).
- Pressing CONTROL ◀ decreases the sound output level (from +10 to –10).

When using the remote control

- 1 Press SOUND. 10 keys now work for sound adjustments.
- 2 Press SUBWOOFER +/- to adjust the sound output level (from –10 to +10).

Tuner Operations

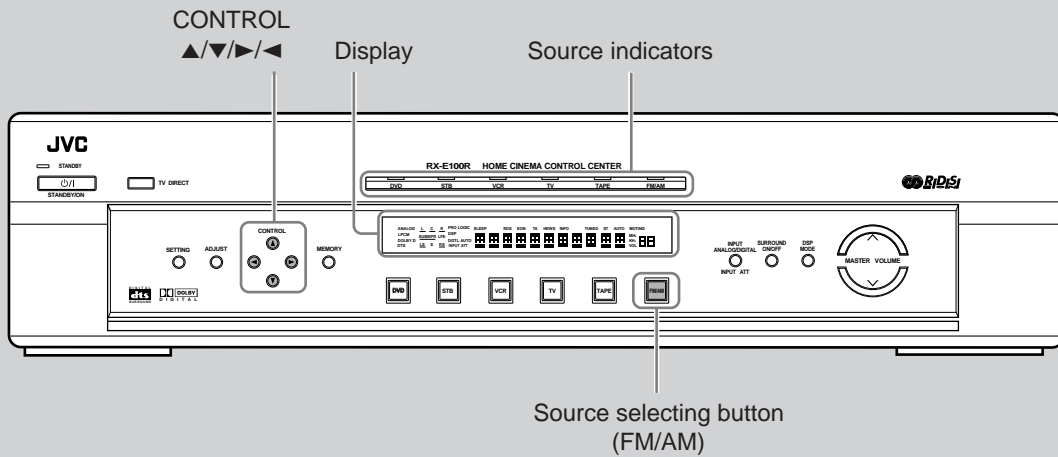

Tuning in Stations Manually

1 Press FM/AM to select the band.

The last received station of the selected band is tuned in, and the CONTROL buttons now work for tuner operations.

- Each time you press the button, the band alternates between FM and AM (MW/LW).

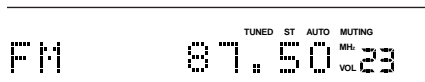

Ex.: When selecting the FM band

2 Press CONTROL ▼ (or ▲) repeatedly until “< TUNING >” appears on the display.

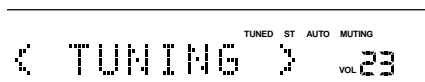

Then

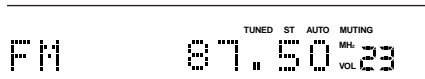

3 Press repeatedly or hold CONTROL ▶ or ◀ until you find the frequency you want.

CONTROL

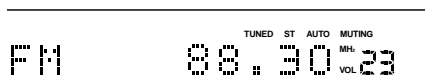

- Pressing (or holding) CONTROL ▶ increases the frequencies.
- Pressing (or holding) CONTROL ◀ decreases the frequencies.

When using the remote control

- 1 Press FM or AM.
- 2 Press repeatedly or hold TUNING UP/DOWN until you find the frequency you want.
 - Pressing (or holding) TUNING UP increases the frequencies.
 - Pressing (or holding) TUNING DOWN decreases the frequencies.

Notes:

- When you hold and release CONTROL ▶ (TUNING UP on the remote control) or CONTROL ◀ (TUNING DOWN on the remote control), the frequency keeps changing until a station is tuned in.
- When a station of sufficient signal strength is tuned in, the TUNED indicator lights up on the display.
- When an FM stereo program is received, the ST (Stereo) indicator also lights up.

Tuner Operations

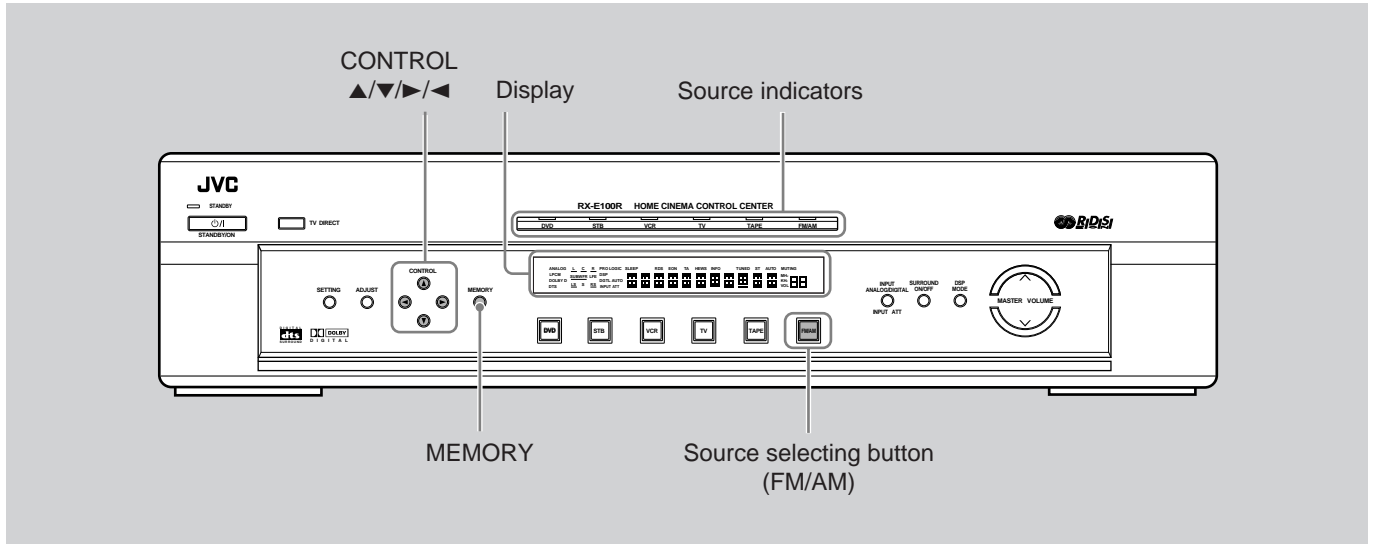

Using Preset Tuning

Once a station is assigned to a channel number, the station can be quickly tuned. You can preset up to 30 FM and 15 AM (MW/LW) stations.

To store the preset stations

Before you start, remember...

There is a time limit in doing the following steps. If the setting is canceled before you finish, start from step 1 again.



1 Tune in the station you want to preset (see "Tuning in Stations Manually" on page 23).

- If you want to store the FM reception mode for this station, select the FM reception mode you want. See "Selecting the FM Reception Mode" on page 25.



2 Press MEMORY.

The channel number position starts flashing on the display for about 10 seconds.



3 Press CONTROL ► (or ◀) to select a channel number while the channel number position is flashing.

CONTROL

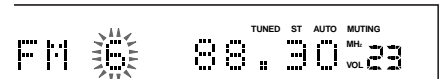

4 Press MEMORY again while the selected channel number is flashing on the display.

The selected channel number stops flashing.

The station is assigned to the selected channel number.

MEMORY

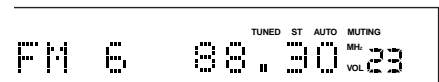

5 Repeat steps 1 to 4 until you store all the stations you want.

To erase a stored preset station

Storing a new station on a used channel number erases the previously stored one.

To tune in a preset station

1 Press FM/AM to select the band.

The last received station of the selected band is tuned in, and the CONTROL buttons now work for tuner operations.

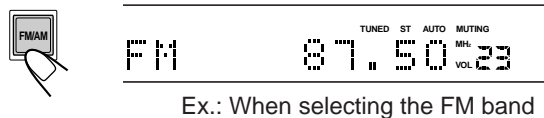

2 Press CONTROL ▼ (or ▲) repeatedly until “< PRESET >” appears on the display.

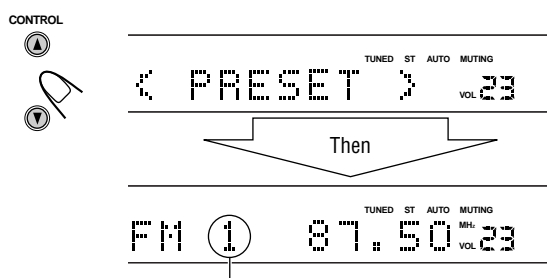

Preset channel number appears.

3 Press CONTROL ► or ◀ to select a preset channel number you want.

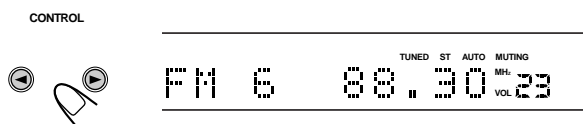

- Pressing (or holding) CONTROL ► increases the preset channel numbers.
- Pressing (or holding) CONTROL ◀ decreases the preset channel numbers.

When using the remote control

- 1 Press FM or AM.
The last received station of the selected band is tuned in, and the 10 keys now work for tuner operations.
- 2 Press the 10 keys to select a preset channel number.
 - For channel number 5, press 5.
 - For channel number 15, press +10 then 5.
 - For channel number 30, press +10, +10, then 10.

Selecting the FM Reception Mode



When an FM stereo broadcast is hard to receive or noisy, you can change the FM reception mode while receiving an FM broadcast.

- You can store the FM reception mode for each preset station.

Before you start, remember...

There is a time limit in doing the following steps. If the setting is canceled before you finish, start from step 1 again.

1 While listening to an FM station, press CONTROL ▼ (or ▲) repeatedly until “< FM MODE >” appears on the display.



2 Press CONTROL ► (or ◀) to select “MONO.”

- Each time you press the button, the FM reception mode alternates between “AUTO MUTING” and “MONO.”

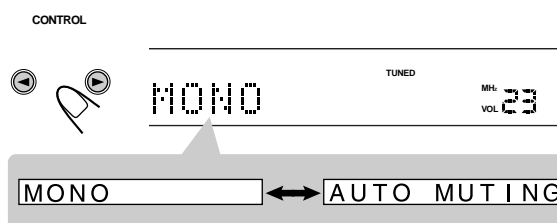

* “AUTO MUTING” is the initial setting.

MONO : Select this to improve the reception (but stereo effect will be lost).
In this mode, you will hear noise while tuning into the stations. The AUTO MUTING indicator goes off from the display. (The ST indicator also goes off.)

AUTO MUTING : Normally select this. When a program is broadcasted in stereo, you will hear stereo sound; when in monaural, you will hear monaural sounds. This mode is also useful to suppress static noise between stations. The AUTO MUTING indicator lights up on the display.

To restore the stereo effect

Repeat step 1, then select “AUTO MUTING” in step 2.

Tuner Operations

You need to set RDS/DVD MENU selector to "RDS," when you want to operate RDS.

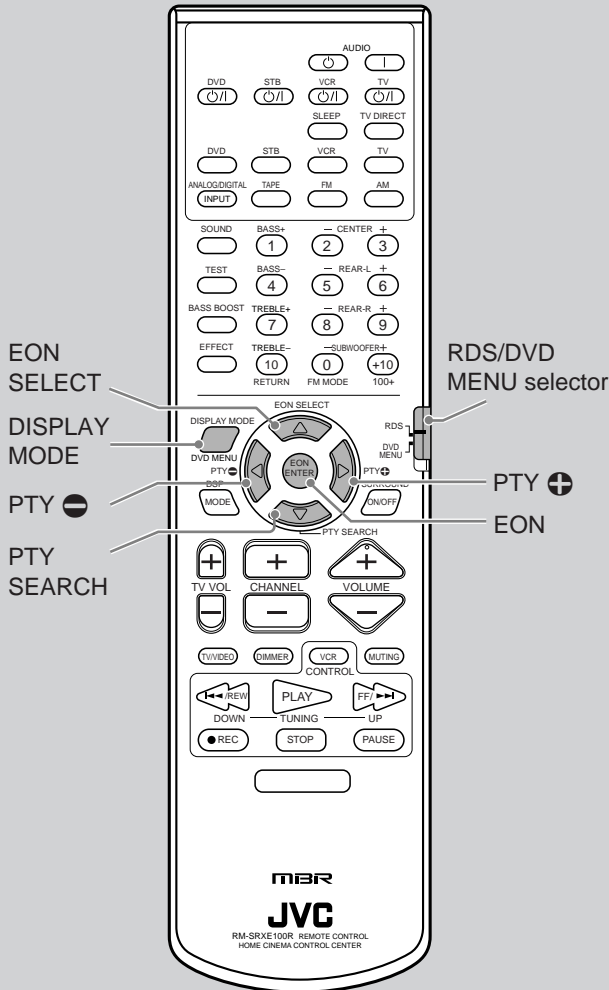

With the unit, you can receive the following types of RDS signals.

- PS (Program Service):** Shows commonly known station names
- PTY (Program Type):** Shows types of broadcast programs
- RT (Radio Text):** Shows text messages the station sends
- EON (Enhanced Other Network):** See page 28.

Notes:

- RDS is not available for AM (MW/LW) broadcasts.
- RDS may not operate correctly if the station tuned is not transmitting RDS signal properly or if the signal strength is weak.

What information can RDS signals provide?

You can see the RDS signals the station sends on the display.

To show the RDS signals

- 1 Set RDS/DVD MENU mode selector to "RDS."

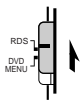

- 2 Press DISPLAY MODE while listening to an FM station.



- Each time you press the button, the display changes to show you the following information:

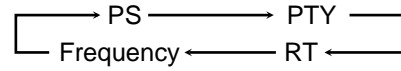

PS (Program Service):

While searching, "PS" appears and then the station names will be displayed. "NO PS" appears if no signal is sent.

PTY (Program Type):

While searching, "PTY" appears and then the type of the broadcast program will be displayed. "NO PTY" appears if no signal is sent.

RT (Radio Text):

While searching, "RT" appears and then text messages the station sends will be displayed. "NO RT" appears if no signal is sent.

Frequency:

Station frequency (non-RDS service)

Using the RDS (Radio Data System) to Receive FM Stations



RDS allows FM stations to send an additional signal along with their regular program signals. For example, the stations send their station names, as well as information about what type of program they broadcast, such as sports or music, etc.

When tuned to an FM station which provides the RDS service, the RDS indicator lights up on the display.

About characters shown on the display

When the display shows PS, PTY, or RT signals, the following characters are used.

- The display cannot differentiate upper case and lower case letters and always uses upper case letters.
- The display cannot show accented letters, "A," for instance, may stand for accented "A's" like "Å, Ä, Æ, Á, À, Â, ã, ä, å, and â."

Note:

If searching finishes at once, "PS," "PTY," and "RT" will not appear on the display.

Searching for a Program by PTY Codes



One of the advantages of the RDS service is that you can locate a particular kind of program from the preset channels (see page 24) by specifying the PTY codes.

To search for a program using the PTY codes

Before you start, remember...

- The PTY Search is only applicable to preset stations.
- To stop searching any time during the process, press PTY SEARCH while searching.
- There is a time limit in doing the following steps. If the setting is canceled before you finish, start from step 1 again.

1 Set RDS/DVD MENU mode selector to "RDS."



2 Press PTY SEARCH while listening to an FM station.

"PTY SELECT" flashes on the display.



3 Press PTY ⊕ or PTY ⊖ until the PTY code you want appears on the display, while "PTY SELECT" is flashing.

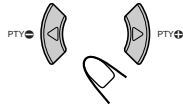

• For details, see "Description of the PTY codes" on page 28.

4 Press PTY SEARCH again, while the PTY code selected in the previous step is still on the display.



While searching, "SEARCH" and the selected PTY code alternate on the display.

The unit searches 30 preset FM stations, stops when it finds the one you have selected, and tunes in that station.

To continue searching after the first stop

Press PTY SEARCH again while the indications on the display are flashing.

If no program is found, "NOT FOUND" appears on the display.

PTY codes



Tuner Operations

You need to set RDS/DVD MENU mode selector to "RDS," when you want to operate RDS.

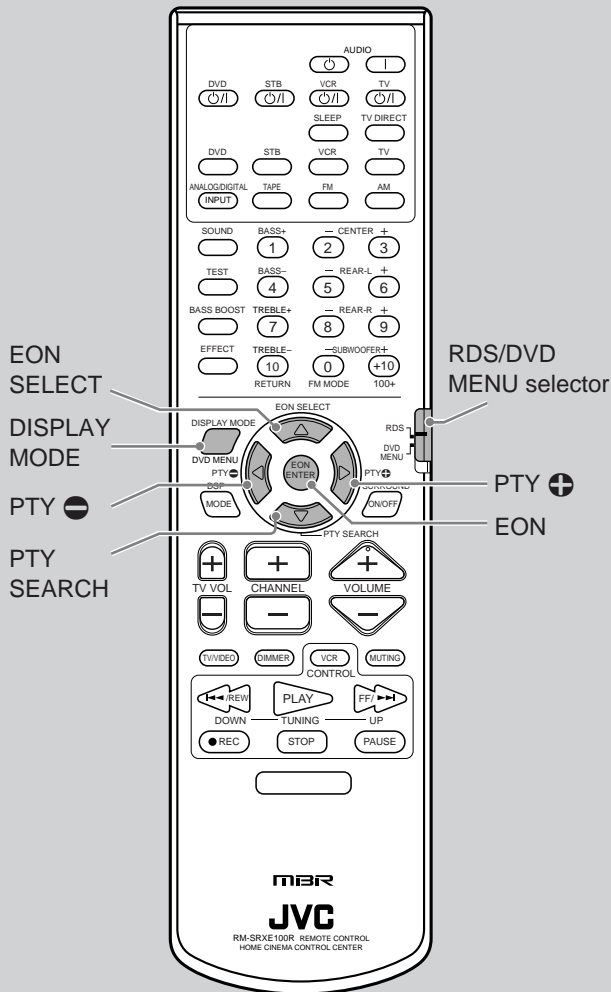

Description of the PTY codes:

NEWS:	News.
AFFAIRS:	Topical program expanding or enlarging upon the news — debate, or analysis.
INFO:	Programs the purpose of which is to impart advice in the widest sense.
SPORT:	Programs concerned with any aspect of sports.
EDUCATE:	Educational programs.
DRAMA:	All radio plays and serials.
CULTURE:	Programs concerning any aspect of national or regional culture, including language, theater, etc.
SCIENCE:	Programs about natural sciences and technology.
VARIED:	Used for mainly speech-based programs such as quizzes, panel games and personality interviews.
POP M:	Commercial music of current popular appeal.
ROCK M:	Rock music.
EASY M:	Current contemporary music considered to be "easy-listening."
LIGHT M:	Instrumental music, and vocal or choral works.
CLASSICS:	Performances of major orchestral works, symphonies, chamber music, etc.
OTHER M:	Music not fitting into any of the other categories.
WEATHER:	Weather reports and forecasts.
FINANCE:	Stock Market reports, commerce, trading etc.
CHILDREN:	Programs targeted at a young audience.
SOCIAL:	Programs about sociology, history, geography, psychology and society.
RELIGION:	Religious programs.
PHONE IN:	Involving members of the public expressing their views either by phone or at a public forum.
TRAVEL:	Travel information.
LEISURE:	Programs about recreational activities.
JAZZ:	Jazz music.
COUNTRY:	Songs which originate from, or continue the musical tradition of the American Southern States.
NATION M:	Current popular music of the nation or region in that country's language.
OLDIES:	Music from the so-called "golden age" of popular music.
FOLK M:	Music which has its roots in the musical culture of a particular nation.
DOCUMENT:	Programs concerning factual matters, presented in an investigative style.
TEST:	Broadcasts for testing emergency broadcast equipment or unit.
ALARM !:	Emergency announcement.

Classification of the PTY codes for some FM stations may be different from the above list.

Switching to Broadcast Program of Your Choice Temporarily



Another convenient RDS service is called “EON (Enhanced Other Network).”

The EON indicator works and lights up while receiving an FM station with the EON code.

This allows the unit to switch temporarily to a broadcast program of your choice (TA, NEWS, and/or INFO) from a different station except in the following cases:

- When you are listening to non-RDS stations (all AM — MW/LW and some FM stations).
- When the unit is in standby mode or TV Direct.
- When the unit selects the other source.

Before you start, remember...

- The EON function is only applicable to preset stations.

1 Set RDS/DVD MENU mode selector to “RDS.”



2 Press EON so that the last selected program type appears on the display.



The unit enters EON standby mode. When the unit is in EON standby mode, the unit is ready to receive the EON data (TA/NEWS/INFO) you select.

3 Press EON SELECT until the program type you want appears on the display.



- Each time you press the button, the display changes to show the following:

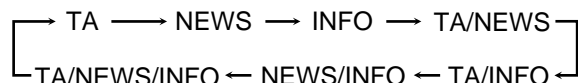

TA	: Traffic Announcement in your area.
NEWS	: News.
INFO	: Program the purpose of which is to impart advice in the widest sense.

How the EON function actually works:

CASE 1

If there is no station broadcasting the program you have selected

The unit continues tuning in the current station.



When a station starts broadcasting the program you have selected, the unit automatically switches to the station. The indicator of received PTY code starts flashing.



When the program is over, “EON END” appears in the display, and the unit goes back to the previously tuned station, but the EON function still remains activated.

CASE 2

If there is a station broadcasting the program you have selected

The unit tunes in the program. The indicator of received PTY code starts flashing.



When the program is over, “EON END” appears in the display, and the unit goes back to the previously tuned station, but the EON function still remains activated.

CASE 3

If the FM station you are listening to is broadcasting the program you have selected

The unit continues to receive the station but the indicator of received PTY code starts flashing.



When the program is over, “EON END” appears in the display, and the indicator of received PTY code stops flashing and remains lit, but the EON function still remains activated.

To stop listening to the program selected by EON

Press EON so that the program type (TA/NEWS/INFO) indicator goes off from the display. The unit enters EON off mode and goes back to the previously selected source.

- Each time you press EON, the EON mode alternates between standby mode and off mode.

When an emergency broadcast (ALARM ! signal) is sent from an FM station:

The unit automatically tunes in the station except in the following cases:

- When you are listening to non-RDS stations (all AM — MW/LW and some FM stations).
- When the unit is in standby mode or TV Direct.
- When the unit selects the other source.

While receiving an emergency broadcast, “ALARM !” appears on the display.

The TEST signal is used for equipment test — whether it can receive the ALARM ! signal correctly.

The TEST signal makes the unit work in the same way as the ALARM ! signal does. If the TEST signal is received, the unit automatically switches to the station broadcasting the TEST signal. While receiving the TEST signal, “TEST” appears on the display.

Notes:

- EON data sent from some stations may not be compatible with this unit.
- While listening to a program tuned in by the EON function, the station does not change even if another network station starts broadcasting a program of the same EON data.
- While listening to a program tuned in by the EON function, you can only use the EON and DISPLAY MODE buttons as the tuner operation buttons.
- If the stations alternate intermittently between the station tuned by the EON function and the currently tuned station (“WAITING” flashes in the display), press EON to cancel the EON function. If you do not press the button, the currently tuned station is received finally, and the indication of the EON data type flashing on the display disappears.

Creating Realistic Sound Fields

You can use the following DSP (Digital Signal Processor) modes to reproduce a realistic sound field.

- Surround modes
- DAP modes

■ Surround modes

Surround modes cannot be used when only the front speakers are connected to this unit (without the rear speakers or center speaker).

Dolby Surround (Dolby Pro Logic)*

Used to reproduce sound tracks of the software encoded with Dolby Surround ( **DOLBY SURROUND**).

Dolby Surround encoding format records the left front channel, right front channel, center channel, and rear channel signals (total 4 channels) into 2 channels.

The **Dolby Pro Logic** decoder built in this unit decodes these 2 channel signals into original 4 channel signals — matrix-based multichannel reproduction, and allows you to enjoy a realistic stereo sound in your listening room.

- When Dolby Pro Logic is activated, the PRO LOGIC indicator lights up on the display.
 - Dolby Pro Logic will be activated for all 2 channel-encoded software.

Dolby Digital*

Used to reproduce multichannel sound tracks of the software encoded with Dolby Digital ( **DOLBY DIGITAL**).

- To enjoy the software encoded with Dolby Digital, connect the source component using the digital terminal on the rear of this unit. (See page 7.)

Dolby Digital encoding method (so-called discrete 5.1 channel digital audio format) records and digitally compresses the left front channel, right front channel, center channel, left rear channel, right rear channel, and LFE channel signals (total 6 channels, but LFE channel is counted as 0.1 channel. Therefore, called 5.1 channel). Since each channel is completely independent from the other channel signals to avoid interference, you can obtain much better sound quality with much stereo and surround effects.

In addition, Dolby Digital enables stereo rear sounds, and sets the cutoff frequency of the rear treble at 20 kHz, compared to 7 kHz for Dolby Pro Logic. These facts enhance the sound movement and being-there feelings much more than Dolby Pro Logic.

DTS Digital Surround**

Used to reproduce multichannel sound tracks of the software encoded with DTS Digital Surround ().

- To enjoy the software encoded with DTS Digital Surround, connect the source component using the digital terminal on the rear of this unit. (See page 7.)

DTS Digital Surround is another discrete 5.1 channel digital audio format available on CD, LD, and DVD software.

Compared to Dolby Digital, audio compression rate is relatively low. This fact allows DTS Digital Surround format to add breadth and depth to the reproduced sounds. As a result, DTS Digital Surround features natural, solid and clear sound.

JVC Theatre Surround

Used to reproduce sound tracks of the software encoded with Dolby Surround ( **DOLBY SURROUND**).

- **Theatre Surround can be used when the front speakers and the rear speakers are connected to this unit (without regarding the center speaker).**

Theatre Surround can add acoustic surround effects (DAP mode effects) to Dolby Surround software, and create a sound field of a theatre in your listening room.

- When Theatre Surround is selected, the PRO LOGIC and DSP indicators light up on the display.

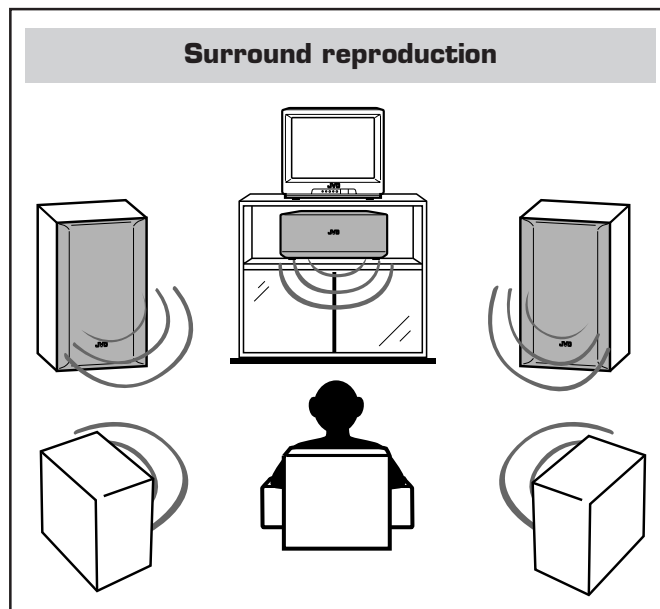

* Manufactured under license from Dolby Laboratories. "Dolby," "Pro Logic," and the double-D symbol are trademarks of Dolby Laboratories. Confidential Unpublished Works. ©1992–1997 Dolby Laboratories, Inc. All rights reserved.

** Manufactured under license from Digital Theater Systems, Inc. US Pat. No. 5,451,942 and other world-wide patents issued and pending. "DTS" and "DTS Digital Surround" are trademarks of Digital Theater Systems, Inc. ©1996 Digital Theater Systems, Inc. All rights reserved.

■ DAP (Digital Acoustic Processor) Modes

DAP modes have been designed to create important acoustic surround elements.

The sound heard in a hall, live club, dance club or pavilion consists of direct sound and indirect sound — early reflections and reflections from behind. Direct sounds reach the listener directly without any reflection. On the other hand, indirect sounds are delayed by the distances of the ceiling and walls (see the diagram to the right).

These indirect sounds are important elements of the acoustic surround effects.

The following DAP modes are provided with this unit.

LIVE CLUB	: Gives the feeling of a live music club with a low ceiling.
DANCE CLUB	: Gives a throbbing bass beat.
HALL	: Gives clear vocal and the feeling of a concert hall.
PAVILION	: Gives the spacious feeling of a pavilion with a high ceiling.

These DAP modes can be used to add the acoustic surround effects while reproducing stereo analog software or Linear PCM digital software, and can give you a real “being there” feeling.

- **DAP modes can be used when the front and rear speakers are connected to this unit (without respect to the center speaker connection: no sound comes out of the center speaker if it is connected).**
- When one of the DAP modes is selected, the DSP indicator lights up on the display.

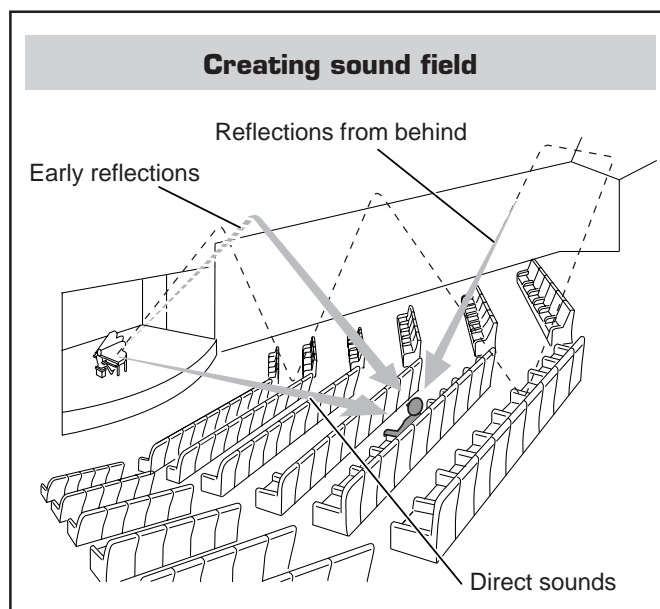

Available DSP modes according to the input signal format

○: Possible ×: Impossible

DSP Modes		SURROUND	THEATRE	LIVE CLUB	DANCE CLUB	HALL	PAVILION	STEREO
Input Signal format	Analog (Dolby Pro Logic)	○	○	○	○	○	○	○
	Linear PCM (Dolby Pro Logic)	○	○	○	○	○	○	○
	Dolby Digital (Dolby Digital) *1	○	×	×	×	×	×	○
	DTS (DTS Digital Surround) *2	○	×	×	×	×	×	○

*1 Dolby Digital is activated except when 2 channel signals come in (in this case, Dolby Pro Logic is activated).

*2 DTS Digital Surround is activated except when 2 channel signals come in (in this case, Dolby Pro Logic is activated).







Creating Realistic Sound Fields

About Relations between Speaker Layout and DSP Modes

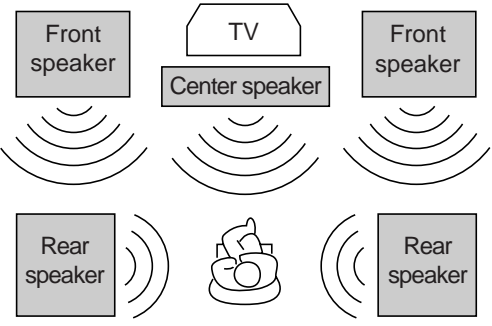
Available DSP modes will vary depending on how many speakers are used with this unit.

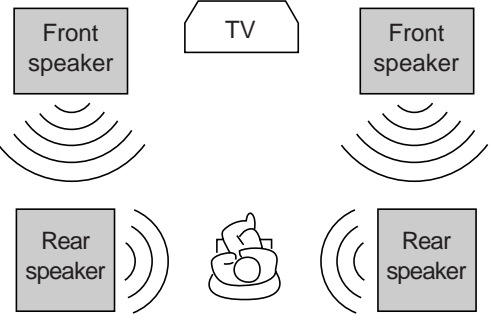
Make sure that you have set the speaker information correctly (see page 15).

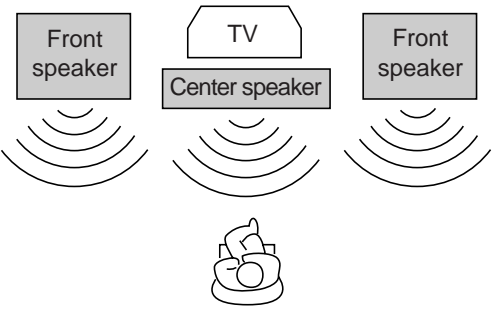
- If only front speakers are connected, you cannot use the DSP modes.
- If rear speakers are not connected, you cannot use Theater Surround and the DSP modes.

Speaker Layouts	Available DSP modes
<p>5 Channels</p> 	<p>Surround mode</p> <p>Each time you press SURROUND ON/OFF, Surround mode turns on or off (“STEREO”):</p>  (Remote)  (Front panel)
<p>4 Channels</p> 	<p>DSP mode</p> <p>Each time you press DSP MODE, the DSP modes (Theatre Surround and DAP modes) change as follows:</p>  (Remote)  (Front panel)
<p>3 Channels</p> 	<p>Surround mode</p> <p>Each time you press SURROUND ON/OFF, Surround mode turns on or off (“STEREO”):</p>  (Remote)  (Front panel)

When “AUTO SR (Auto Surround)” is turned “ON”

Surround mode is automatically activated when you select and start playing back a multichannel source.

It will be convenient for you to use the remote control for DSP operations, since you can adjust them from your listening point, and use the test signal.

- When using the buttons on the front panel, see pages 37 to 39.

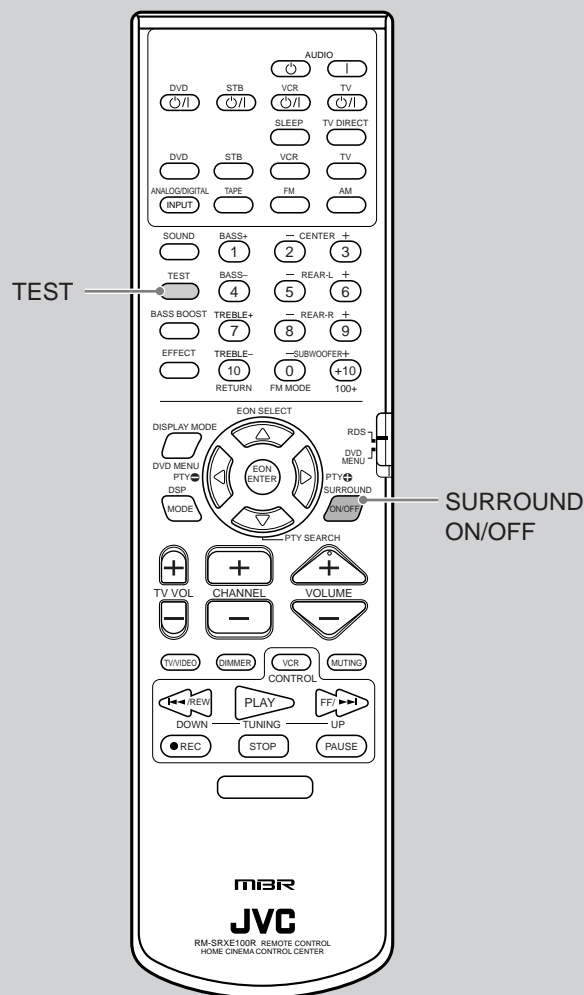

Using Surround Modes (Remote Control)

Surround mode cannot be used with another DSP mode. Once Surround mode is activated, the other DSP mode in use will be canceled.

- You have to make this adjustment for each source.

1 Select and play software encoded with Dolby Surround, Dolby Digital, or DTS Digital Surround.

If "AUTO SR (Auto Surround)" is set to "ON"

Playing a digital source automatically activates an appropriate Surround mode. (See pages 18 and 19.)

2 Press SURROUND ON/OFF to activate an appropriate Surround mode — Pro Logic, Dolby Digital, or DTS Digital Surround.

- Each time you press the button, Surround mode turns on and off alternately.



SURROUND ON VOL 23

Then

DOLBY D VOL 23

Ex.: When Dolby Digital is activated

Note:

When playing back an analogue source, "SURROUND ON" will not appear, and "PRO LOGIC" appears as soon as you press SURROUND ON/OFF. (The PRO LOGIC indicator also lights up on the display.)

3 Press TEST to check the speaker output balance.



TEST L VOL 23

"TEST L" starts flashing on the display, and a test tone comes out of the speakers in the following order:

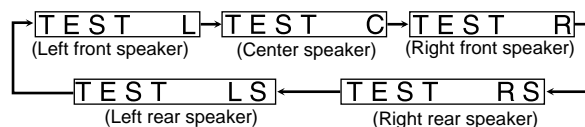

Notes:

- You can adjust the speaker output levels without outputting the test tone.
- No test tone comes out of the center speaker when "CTR SP" is set to "NO."
- No test tone comes out of the rear speakers when "REAR SP" is set to "NO."

Before you start, remember...

- Make sure that you have set the speaker information correctly (see page 15).
- You cannot adjust the center speaker output level when you have set "CTR SP" to "NO."
- You cannot adjust the rear speaker output levels when you have set "REAR SP" to "NO."
- Remember not to change the speaker setting while using any DSP mode; otherwise, it may be canceled when you deactivate the speakers required for the DSP mode.

TO BE CONTINUED ON THE NEXT PAGE

Creating Realistic Sound Fields

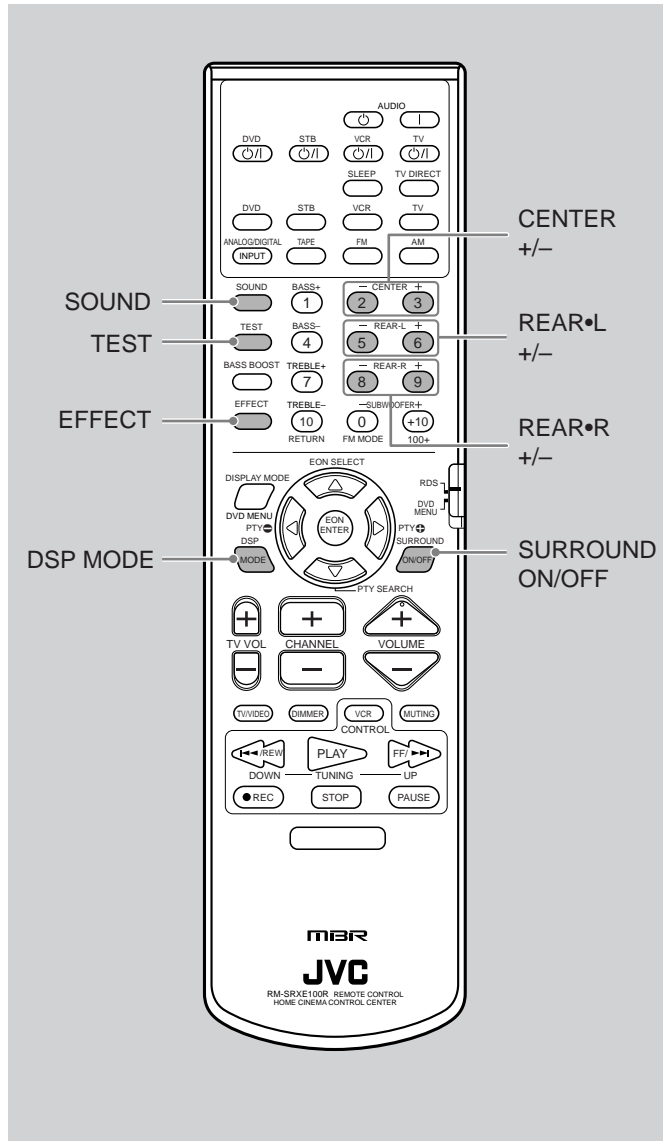

4 Press SOUND.



The 10 keys now work for sound adjustments.

5 Adjust the following speaker output levels (from -10 to +10).

- Make adjustments so that the sound level of the selected speaker is set at the same level as that of the front speakers.

To adjust the center speaker level, press CENTER +/-.

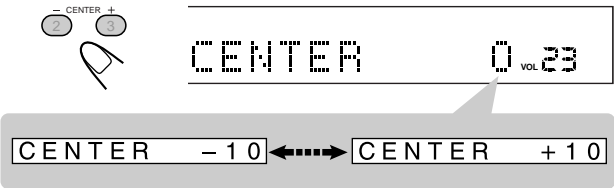

To adjust the left rear speaker level, press REAR•L +/-.

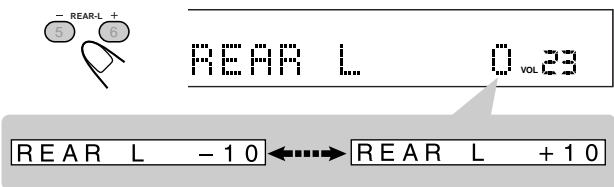

To adjust the right rear speaker level, press REAR•R +/-.

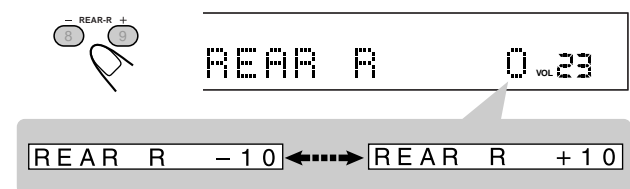

6 Press TEST again to stop the test tone.



To cancel Surround Mode

Press SURROUND ON/OFF again so that "STEREO" appears on the display.

- If Surround mode is canceled while playing back multichannel digital software, all channel signals are mixed and output through the front speakers (and subwoofer if you have connected a subwoofer and set the subwoofer setting correctly – "YES").

Using Theatre Surround (Remote Control)

Theatre Surround cannot be used with another DSP mode. Once Theatre Surround is activated, the other DSP mode in use will be canceled.

- You have to make this adjustment for each source.
- You cannot use Theater Surround if no rear speakers are connected.

1 Select and play software encoded with Dolby Surround.

2 Press DSP MODE repeatedly until “THEATRE” appears on the display.

The PRO LOGIC and DSP indicator light up on the display.

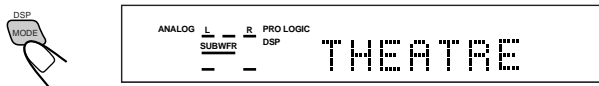

3 Press TEST to check the speaker output balance.

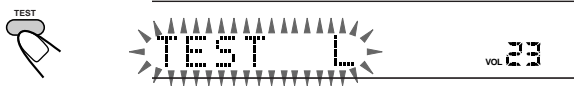

“TEST L” starts flashing on the display, and a test tone comes out of the speakers in the following order:

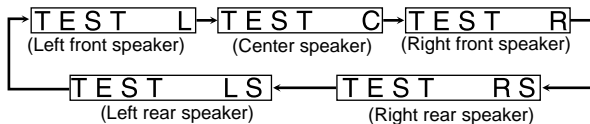

Notes:

- You can adjust the speaker output levels without outputting the test tone.
- No test tone comes out of the center speaker when “CTR SP” is set to “NO.”

4 Press SOUND.

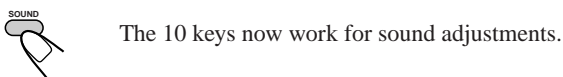

5 Adjust the following speaker output levels (from -10 to +10).

- Make adjustments so that the sound level of the selected speaker is set at the same level as that of the front speakers.

To adjust the center speaker level, press CENTER +/-.



To adjust the left rear speaker level, press REAR•L +/-.



To adjust the right rear speaker level, press REAR•R +/-.



6 Press TEST again to stop the test tone.



7 Press EFFECT to select the DSP effect level (1 to 5) you want.

- As the number increases, the DSP effect becomes stronger (normally set it to “EFFECT 3”).



To cancel Theatre Surround

Press DSP MODE repeatedly until “STEREO” appears on the display. The PRO LOGIC and DSP indicators go off.

Creating Realistic Sound Fields

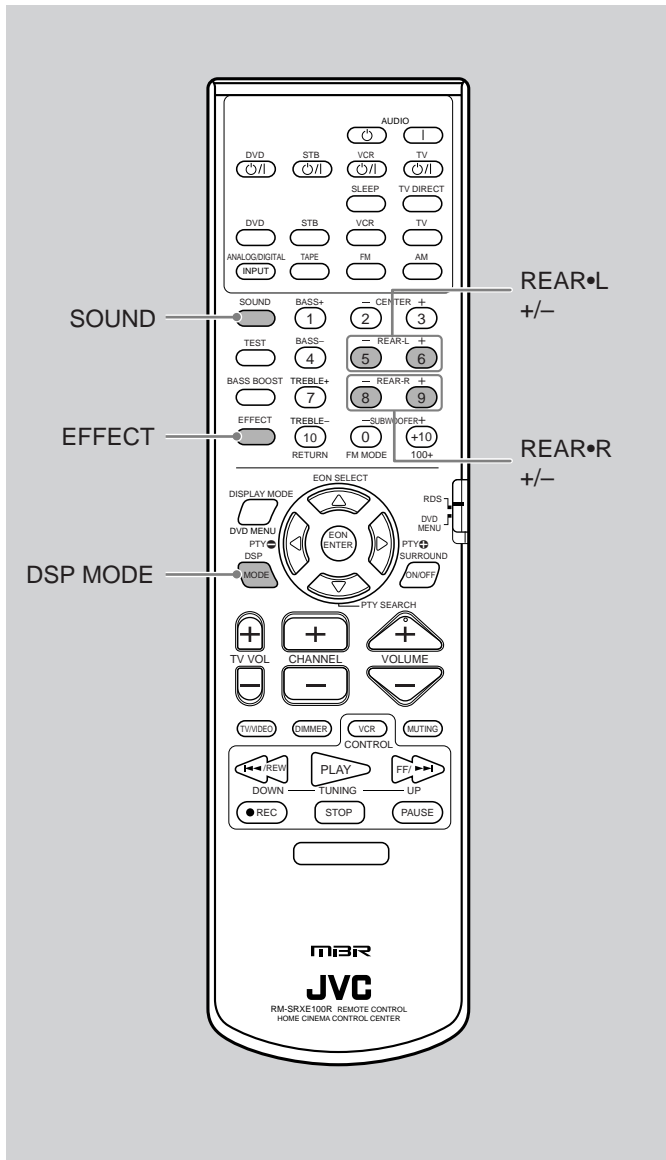

2 Press DSP MODE repeatedly until one of the DAP modes appears on the display.

The DSP indicator lights up on the display.

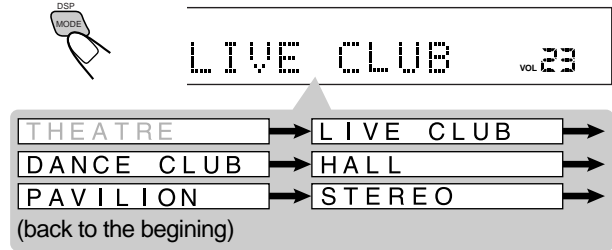

3 Press SOUND.



The 10 keys now work for sound adjustments.

4 Adjust the rear speaker output levels (from -10 to +10).

- Make adjustments so that the sound level of the selected speaker is set at the same level as that of the front speakers.

To adjust the left rear speaker level, press REAR•L +/-.

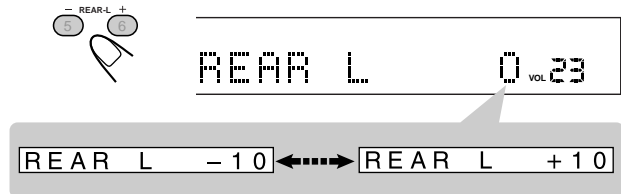

To adjust the right rear speaker level, press REAR•R +/-.

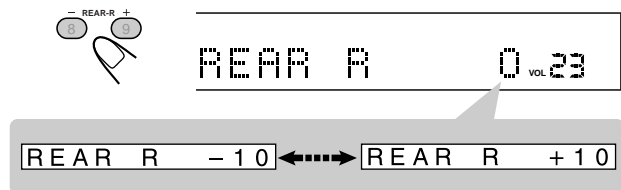

Using DAP Modes (Remote Control)

A DAP mode cannot be used with another DSP mode. Once one of the DAP modes is activated, the other DSP mode in use will be canceled.

- You have to make this adjustment for each source.
- You cannot use the DAP modes if no rear speakers are connected.

1 Select and play stereo analogue software or Linear PCM digital software.

5 Press EFFECT to select the DSP effect level (1 to 5) you want.

- As the number increases, the DSP effect becomes stronger (normally set it to "EFFECT 3").

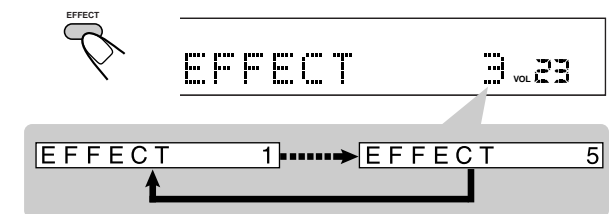

To cancel DAP Mode

Press DSP MODE repeatedly so that "STEREO" appears on the display. The DSP indicator goes off.

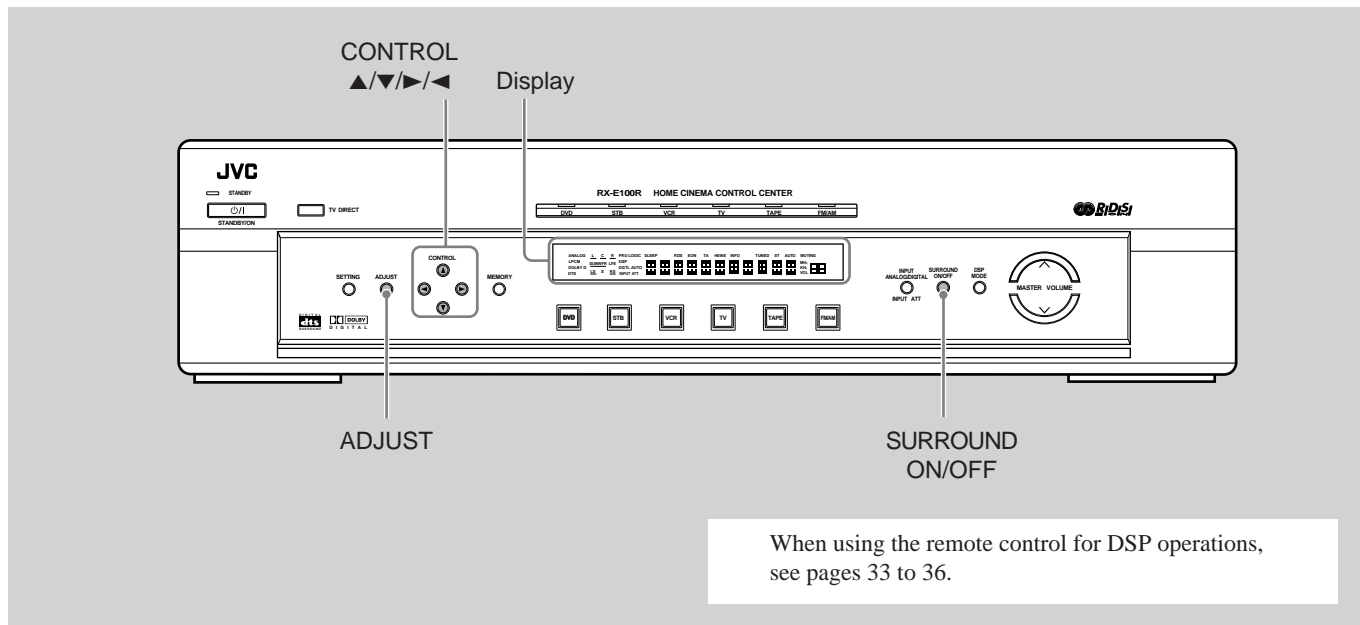

Before you start, remember...

- Make sure that you have set the speaker information correctly (see page 15).
- You cannot adjust the center speaker output level when you have set "CTR SP" to "NO."
- You cannot adjust the rear speaker output levels when you have set "REAR SP" to "NO."

Using Surround Modes (Front Panel)

Surround mode cannot be used with another DSP mode. Once Surround mode is activated, the other DSP mode in use will be canceled.

When using the buttons on the front panel, no test tone is available. Make adjustments while listening to the sound of the source played back.

- You have to make this adjustment for each source.

1 Select and play software encoded with Dolby Surround, Dolby Digital, or DTS Digital Surround.

If "AUTO SR (Auto Surround)" is set to "ON"
Playing a digital source automatically activates an appropriate Surround mode. (See pages 18 and 19.)

2 Press SURROUND ON/OFF to activate an appropriate Surround mode — Pro Logic, Dolby Digital, or DTS Digital Surround.

- Each time you press the button, Surround mode turns on and off alternately.

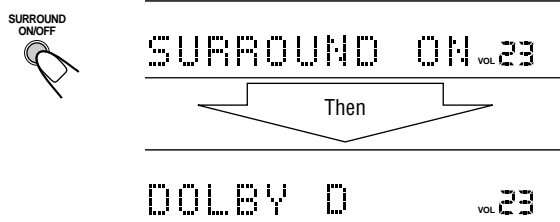

Note:
Ex.: When Dolby Digital is activated
When playing back an analogue source, "SURROUND ON" will not appear, and "PRO LOGIC" appears as soon as you press SURROUND ON/OFF. (The PRO LOGIC indicator also lights up on the display.)

3 Press ADJUST.

The CONTROL buttons now work for sound adjustments.

4 Press CONTROL ▼ (or ▲) repeatedly until one of the following indications (with the current setting)* appears.

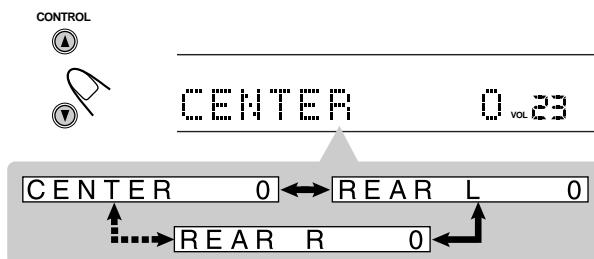

TO BE CONTINUED ON THE NEXT PAGE

Creating Realistic Sound Fields

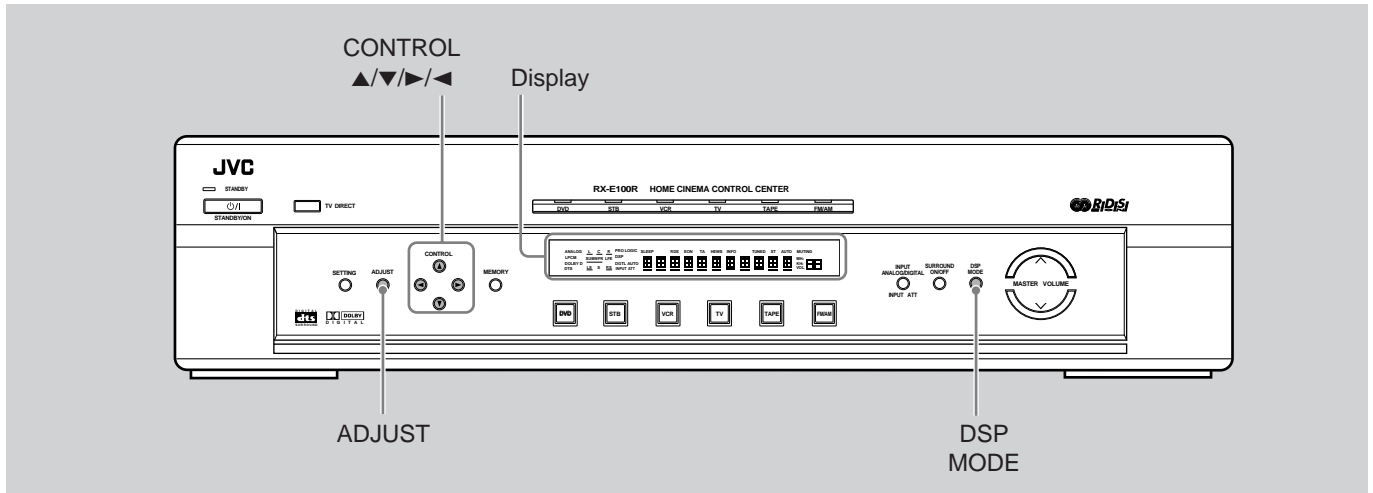

- CENTER** : To adjust the center speaker output level (from -10 to +10).
- REAR L** : To adjust the left rear speaker output level (from -10 to +10).
- REAR R** : To adjust the right rear speaker output level (from -10 to +10).

* "0" is the initial setting for these speaker output levels. If you have already changed the setting, another setting will be shown.

5 Press CONTROL ► (or ◀) to adjust the speaker output level.

- Make adjustments so that the sound level of the selected speaker is set at the same level as that of the front speakers.

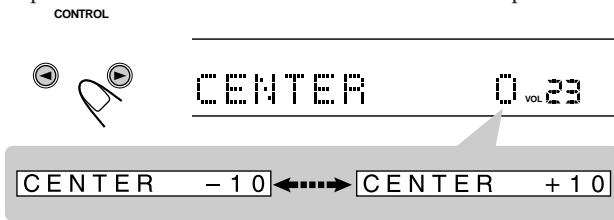

Ex.: When adjusting the center speaker output level

6 Repeat steps 4 and 5 to adjust the other speaker levels.

To cancel Surround Mode

Press SURROUND ON/OFF again so that "STEREO" appears on the display.

- If Surround mode is canceled while playing back multichannel digital software, all channel signals are mixed and output through the front speakers (and subwoofer if you have connected a subwoofer and set the subwoofer setting correctly - "YES").

Using Theatre Surround (Front Panel)

Theatre Surround cannot be used with another DSP mode. Once Theatre Surround is activated, the other DSP mode in use will be canceled.

When using the buttons on the front panel, no test tone is available. Make adjustments while listening to the sound of the source played back.

- You have to make this adjustment for each source.
- You cannot use Theater Surround if no rear speakers are connected.

1 Select and play software encoded with Dolby Surround.

2 Press DSP MODE repeatedly until "THEATRE" appears on the display.

The PRO LOGIC and DSP indicators light up on the display.

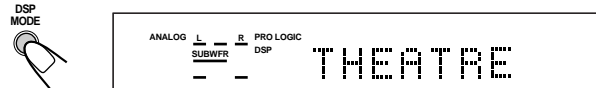

3 Press ADJUST.

The CONTROL buttons now work for sound adjustments.

4 Press CONTROL ▼ (or ▲) repeatedly until one of the following indications (with the current setting)* appears.

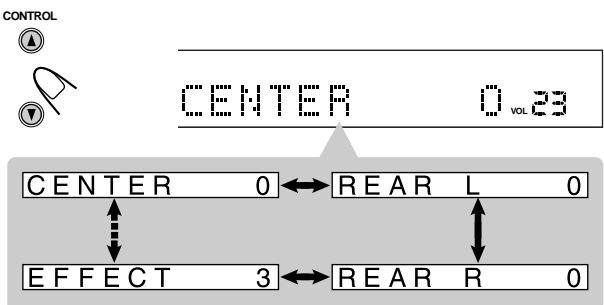

- CENTER** : To adjust the center speaker output level (from -10 to +10).
- REAR L** : To adjust the left rear speaker output level (from -10 to +10).
- REAR R** : To adjust the right rear speaker output level (from -10 to +10).
- EFFECT** : To adjust the DSP effect level. As the number increases, the effect becomes stronger (normally set it to "EFFECT 3").

* "0" is the initial setting for the speaker output levels, and "EFFECT 3" is for the DSP effect level.
If you have already changed the setting, another setting will be shown.

5 Press CONTROL ► (or ◀) to make an adjustment.

- When adjusting the speaker output levels, make adjustments so that the sound level of the selected speaker is set at the same level as that of the front speakers.

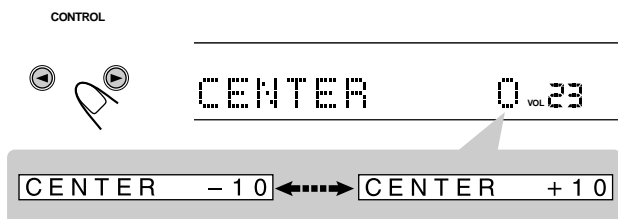

Ex.: When adjusting the center speaker output level

6 Repeat steps 4 and 5 to make other adjustments.

To cancel Theatre Surround

Press DSP MODE repeatedly until "STEREO" appears on the display. The PRO LOGIC and DSP indicators go off.

Using DAP Modes (Front Panel)

A DAP mode cannot be used with another DSP mode. Once one of the DAP modes is activated, the other DSP mode in use will be canceled.

- You have to make this adjustment for each source.
- You cannot use the DAP modes if no rear speakers are connected.

1 Select and play stereo analogue software or Linear PCM digital software.

2 Press DSP MODE repeatedly until one of the DAP modes appears on the display.

The DSP indicator lights up on the display.

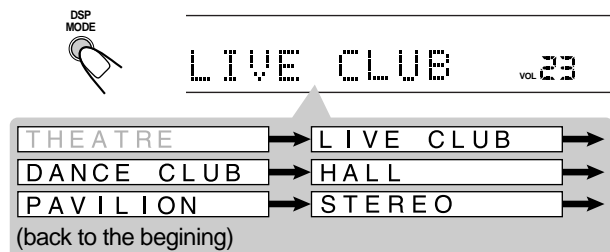

3 Press ADJUST.

The CONTROL buttons now work for sound adjustments.

4 Press CONTROL ▼ (or ▲) repeatedly until one of the following indications (with the current setting)* appears.

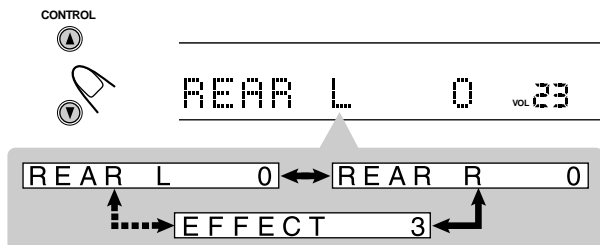

- REAR L** : To adjust the left rear speaker output level (from -10 to +10).
- REAR R** : To adjust the right rear speaker output level (from -10 to +10).
- EFFECT** : To adjust the DSP effect level. As the number increases, the effect becomes stronger (normally set it to "EFFECT 3").

* "0" is the initial setting for the speaker output levels, and "EFFECT 3" is for the DSP effect level.
If you have already changed the setting, another setting will be shown.

5 Press CONTROL ► (or ◀) to make an adjustment.

- When adjusting the speaker output levels, make adjustments so that the sound level of the selected speaker is set at the same level as that of the front speakers.

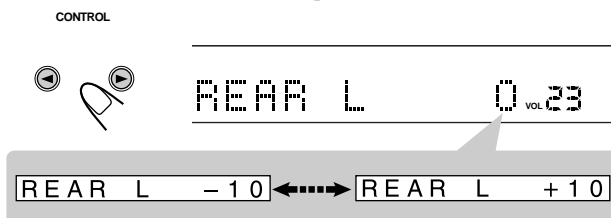

Ex.: When adjusting the left rear speaker output level

6 Repeat steps 4 and 5 to make other adjustments.

To cancel DAP Mode

Press DSP MODE repeatedly so that "STEREO" appears on the display. The DSP indicator goes off.

Mastering Remote Operations

You can use the remote control to operate not only this unit but also other JVC products.

- Refer also to the manuals supplied for the other products.
 - This remote control can operate a VCR whose remote control code is set to A code.
- To operate the other products, aim the remote control directly at the remote sensor on the target product.

■ Operating this unit

- **Turning on the Power — POWER buttons**
(see also page 10)

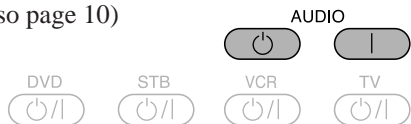

AUDIO : Turn off this unit.

AUDIO : Turn on this unit.

- **Selecting the source — Source selecting buttons** (see also page 10)

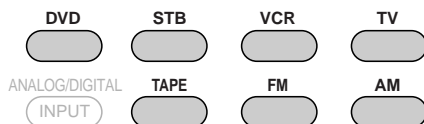

DVD : Select the DVD player.

STB : Select STB.

VCR : Select the VCR.

TV : Select the TV.

TAPE : Select the cassette recorder.

FM : Select the FM band.

AM : Select the AM band.

These buttons also change the functions of the 10 keys, and make them work to operate the target source components. (See the next page.)

- **Adjusting the volume — VOLUME buttons**
(see also page 10)



Adjust the volume level.

- **Activating the TV Direct — TV DIRECT button** (see also page 11)

TV DIRECT Activate the TV Direct.

- **Turning off the sound temporarily — MUTING button** (see also page 12)

MUTING Turn on or off the sound output.

- **Turning off the unit automatically — SLEEP button** (see also page 12)

SLEEP Set the shut-off time until the unit turns off automatically.

- **Changing the Display Brightness — DIMMER button** (see also page 12)

DIMMER Dim or brighten the display illuminations.

- **Selecting analogue or digital input — ANALOG/DIGITAL INPUT button**
(see also page 13)

ANALOG/DIGITAL INPUT Select either analogue input or digital input for the digital source.

- **Creating realistic sound fields — SURROUND ON/OFF and DSP MODE buttons**
(see also pages 32 – 36)



SURROUND ON/OFF : Turn on or off Surround mode.



DSP MODE : Select the DSP modes (Theatre Surround and DAP modes). Each time you press the button, the DSP modes change.

- **Reinforcing the Bass — BASS BOOST button**
(see also pages 21)

BASS BOOST Turn on or off Bass Boost.

- **Adjusting the sound — SOUND, TEST, EFFECT buttons** (see also pages 32 – 36)



SOUND : Change the functions of 10 keys, and make them work for sound adjustments.



TEST : Turn on or off the test tone output.



EFFECT : Change the DSP effect level.

□ Adjusting the sound and operating tuner — 10 keys

■ After pressing **SOUND**, you can use the 10 keys for sound adjustments. (see also pages 32 – 36)

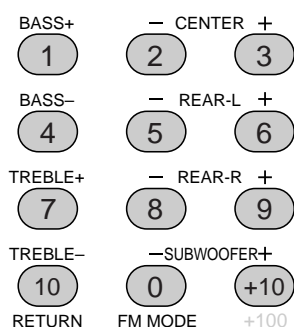

BASS +/-	: Adjust the bass sounds.
TREBLE +/-	: Adjust the treble sounds.
CENTER +/-	: Adjust the center speaker output level.
REAR•L +/-	: Adjust the left rear speaker output level.
REAR•R +/-	: Adjust the right rear speaker output level.
SUBWOOFER +/-	: Adjust the subwoofer level.

■ After pressing **FM** or **AM**, you can use the 10 keys for tuner operations.

1 – 10, +10	: Select a preset channel.
FM MODE (0)	: Change FM MODE.

Example: Selecting preset FM/AM channel numbers using the 10 keys

- For number 5, press 5.
- For number 15, press +10, then 5.
- For number 30, press +10, +10, then 10.

□ Tuning in stations Manually — TUNING UP and TUNING DOWN buttons

(see also page 23)

After pressing **FM** or **AM**, you can change the frequencies by pressing (and holding) the buttons.

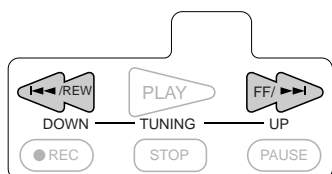

■ Operating other JVC's products

□ Turning on the Power — POWER buttons

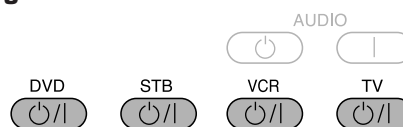

DVD	: Turn on or off a DVD player.
STB	: Turn on or off an STB.
VCR	: Turn on or off a VCR.
TV	: Turn on or off a TV.

□ Selecting the channels and operating tuner — 10 keys

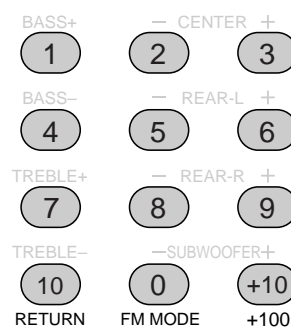

■ After pressing **TV** (source selecting button), you can use the 10 keys for selecting a channel on the TV.

1 – 9, 0, +10 (+100)	: Select a channel.
RETURN (10)	: Function as the RETURN button.

■ After pressing **VCR** (source selecting button) or **VCR CONTROL**, you can use the 10 keys for VCR operations.



If you use VCR CONTROL, you can change the functions of 10 keys for VCR operations without changing the current source.

1 – 9, 0	: Select a channel on the VCR.
-----------------	--------------------------------

■ After pressing **STB**, you can use the 10 keys for STB operations.

1 – 9, 0	: Select a channel.
-----------------	---------------------

Mastering Remote Operations

□ Operating other JVC products — Audio/video operation buttons

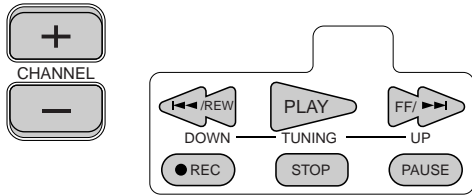

■ After pressing **DVD** (source selecting button), you can use the following buttons for DVD operations.

PLAY : Start playback.

STOP : Stop playback.

PAUSE : Pause playback. To release it, press **PLAY**.

▶▶ : Skip to the beginning of the next track.

◀◀ : Return to the beginning of the current (or previous) track.

■ After pressing **TV** (source selecting button), you can use the following buttons for changing the channels on the TV.

CHANNEL +/- : Change channel numbers.

■ After pressing **VCR** (source selecting button), you can use the following buttons for VCR operations.

CHANNEL +/- : Change channel numbers on the VCR.

PLAY : Start playback.

STOP : Stop playback.

PAUSE : Pause playback. To release it, press **PLAY**.

FF : Fast-wind a tape.

REW : Rewind a tape.

● **REC** :
 • Press this button with the **PLAY** button to start recording pressed and hold.
 • Press this button with the **PAUSE** button to enter recording pause.

■ After pressing **STB** (source selecting button), you can use the following buttons for STB operations.

CHANNEL +/- : Change channel numbers on the STB.

■ These buttons works only for TVs.



TV/VIDEO : Change the input mode (Video input and TV tuner) on the TV.

TV VOL +/- : Adjust the volume on the TV.

□ Operating DVD menu for JVC DVD player

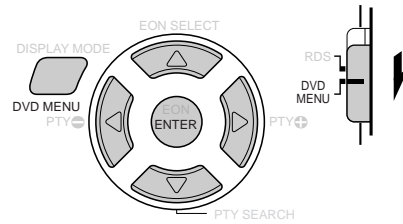

■ After setting **RDS/DVD MENU selector** to “**DVD MENU**,” you can use the buttons illustrated above for DVD menu operations.

DVD MENU : Display or erase the menu screen.

△ / ▽ / ◀ / ▶ : Select an item on the menu screen.

ENTER : Enter a selected item.

■ Operating other Manufacturers' Equipment

By changing the transmittable signals, you can use the remote control supplied for this unit to operate other manufacturers' equipment.

- Refer also to the manuals supplied for the other products.
- To operate these components with the remote control, first you need to set the manufacturer's code each for DVD player, STB, VCR, and TV.
- After replacing batteries of the remote control, set the manufactures' codes again.

□ To change the transmittable signals for operating a DVD player

1. Press and hold DVD $\odot/|$.
2. Press DVD.
3. Enter manufacturer's code using buttons 1–9, and 0.
4. Release DVD $\odot/|$.

Now, you can perform the following operations on the DVD player.

DVD $\odot/$: Turn on or off the DVD player.
PLAY	: Start playback.
STOP	: Stop playback.
PAUSE	: Pause playback. To release it, press PLAY .
▶▶ 	: Skip to the beginning of the next track.
◀◀	: Return to the beginning of the current (or previous) track.

After pressing DVD MENU when setting RDS/DVD MENU selector to "DVD MENU," these buttons can be used for the DVD menu operations.

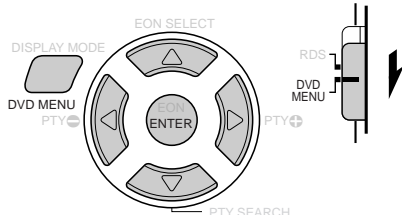

Note:

For detailed menu operations, refer to the instructions supplied with the discs or the DVD player.

5. Try to operate your DVD player by pressing DVD $\odot/|$.

When your DVD player turns on or off, you have entered the correct code.

Manufacturers' codes for DVD player

Manufacturer	Codes
JVC	01
PANASONIC	02
PHILIPS	07
PIONEER	03
SONY	05
TOSHIBA	04
YAMAHA	06

□ To change the transmittable signals for operating an STB

1. Press and hold STB $\odot/|$.
2. Press STB.
3. Enter manufacturer's code using buttons 1–9, and 0.
4. Release STB $\odot/|$.

Now, you can perform the following operations on the STB.

STB $\odot/$: Turn on or off the STB.
CHANNEL +/-	: Change the channels.
1 – 10, 0, +10 (+100)	: Select the channels.

Note:

Refer to the manual supplied with your STB.

5. Try to operate your STB by pressing STB $\odot/|$.

When your STB turns on or off, you have entered the correct code.

If there are more than one code listed for your brand of STB, try each one until the correct one is entered.

Manufacturers' codes for STB

Manufacturer	Codes
JVC	01, 02
AMSTRAD	03 – 06, 33
BT	01
CANAL STELLITE	22
CANAL +	22
D – BOX	26
ECHOSTAR	19 – 21, 23
FINLUX	11
FORCE	30
GALAXIS	29
GRUNDIG	07, 08
HIRSCHMANN	07, 19, 39
ITT NOKIA	11
JERROLD	16
KATHREIN	13, 14, 36
LUXOR	11
MASCOM	34
MASPRO	13
NOKIA	26, 28, 35
PACE	10, 27, 33
PANASONIC	15
PHILIPS	09, 25
RFT	12
SABA	37
SAGEM	24, 31
SALORA	11
SELECTOR	31
SKYMASTER	12, 38
THOMSON	37
TPS	24
TRIAX	32
VIDEOWAY	17, 18
WISI	07

Manufacturers' codes are subject to change without notice. If they are changed, this remote control cannot operate the equipment.

Mastering Remote Operations

❑ To change the transmittable signals for operating an VCR

1. Press and hold VCR \odot/I .
2. Press VCR.
3. Enter manufacturer's code using buttons 1–9, and 0.
4. Release VCR \odot/I .

Now, you can perform the following operations on the VCR.

VCR \odot/I	: Turn on or off the VCR.
CHANNEL +/-	: Change the channels.
1 – 10, 0, +10 (+100)	: Select the channels.
PLAY	: Start playback.
STOP	: Stop playback.
PAUSE	: Pause playback. To release it, press PLAY.
FF	: Fast-wind a tape.
REW	: Rewind a tape.
● REC	: • Press this button with the PLAY button to start recording pressed and hold. • Press this button with the PAUSE button to enter recording pause.

Note:

Refer to the manual supplied with your VCR.

5. Try to operate your VCR by pressing VCR \odot/I .

When your VCR turns on or off, you have entered the correct code.

If there are more than one code listed for your brand of VCR, try each one until the correct one is entered.

Manufacturers' codes for VCR

Manufacturer	Codes
JVC	01
AIWA	02, 20
BELL+HOWELL	03, 16
BLAUPUNKT	04
CGM	03, 05, 16
DAEWOO	34
DIGTAL	05
FISHER	03, 16
G.E.	06
GRUNDIG	07
HITACHI	08, 09
LOEWE	05, 10, 11
MAGNAVOX	04, 05
MITSUBISHI	12 – 15
NOKIA	16
NORDMENDE	17 – 19, 31
ORION	20
PANASONIC	21
PHILIPS	05, 22
PHONOLA	05
SABA	17 – 19, 23, 31
SAMSUNG	24, 25
SANYO	03, 16
SHARP	26, 27
SIEMENS	07
SONY	28 – 30, 35
TELEFUNKEN	17 – 19, 31, 32
TOSHIBA	33

❑ To change the transmittable signals for operating a TV

1. Press and hold TV \odot/I .
2. Press TV.
3. Enter manufacturer's code using buttons 1–9, and 0.
4. Release TV \odot/I .

Now, you can perform the following operations on the TV.

TV \odot/I	: Turn on or off the TV.
TV VOL +/-	: Adjust the volume.
TV/VIDEO	: Set the input mode (either TV or VIDEO)
CHANNEL +/-	: Change the channels.
1 – 9, 0, +10 (+100)	: Select the channels.
RETURN (10)	: Function as the RETURN button.

Note:

Refer to the manual supplied with your TV.

5. Try to operate your TV by pressing TV \odot/I .

When your TV turns on or off, you have entered the correct code.

If there are more than one code listed for your brand of TV, try each one until the correct one is entered.

Manufacturers' codes for TV

Manufacturer	Codes
JVC	01
AKAI	02, 05
BLAUPUNKT	03
DAEWOO	10, 31, 32
FENNER	04, 31, 32
FISHER	05
GRUNDIG	06
HITACHI	07, 08
INNO-HIT	09
IRRADIO	02, 05
MAGNAVOX	10
MITSUBISHI	11, 33
MIVER	03
NOKIA	12, 34
NORDMENDE	13, 14, 18, 26 – 28
OKANO	09
ORION	15
PANASONIC	16, 17
PHILIPS	10
SABA	13, 14, 18, 26 – 28
SAMSUNG	10, 19, 32
SANYO	05
SCHNEIDER	02, 05
SHARP	20
SONY	21 – 25
TELEFUNKEN	13, 14, 18, 26 – 28
THOMSON	13, 14, 18, 26 – 28, 30
TOSHIBA	29

Manufacturers' codes are subject to change without notice. If they are changed, this remote control cannot operate the equipment.

Troubleshooting

Use this chart to help you solve daily operational problems. If there is any problem you cannot solve, contact your JVC service center.

PROBLEM	POSSIBLE CAUSE	SOLUTION
The power does not come on.	The power cord is not plugged in.	Plug the power cord into an AC outlet.
No sound from speakers.	Speaker signal cables are not connected.	Check speaker wiring and reconnect if necessary.
	An incorrect source is selected.	Select the correct source.
	Muting is activated.	Press MUTING to cancel the mute.
	An incorrect input mode (analogue or digital) is selected.	Select the correct input mode (analogue or digital).
Sound from one speaker only.	Connections are incorrect.	Check connections.
	The balance is set to one extreme.	Adjust the balance properly (see page 20).
Continuous hiss or buzzing during FM reception.	Incoming signal is too weak.	Connect an outdoor FM antenna or contact your dealer.
	The station is too far away.	Select a new station.
	An incorrect antenna is used.	Check with your dealer to be sure you have a correct antenna.
Occasional cracking noise during FM reception.	Antennas are not connected properly.	Check connections.
	Ignition noise from automobiles.	Move the antenna farther from automobile traffic.
“OVERLOAD” starts flashing on the display.	Speakers are overloaded because of high volume.	<ol style="list-style-type: none"> 1. Press POWER on the front panel to turn off the unit. 2. Stop the playback source. 3. Turn on the unit again, and adjust the volume.
	Speakers are overloaded because of short circuit of speaker terminals.	Press POWER on the front panel to turn off the unit, then check the speaker wiring. If “OVERLOAD” does not disappear, unplug the AC power cord, then plug it back again. If speaker wiring is not short-circuited, contact your dealer.
The STANDBY lamp lights up after turning on the power, but soon the unit turns off (into standby mode).	The unit is overloaded because of a high voltage.	Press POWER on the front panel to turn off the unit. After unplugging the power cord, consult your dealer.
Remote control does not operate as you intend.	The remote control is not ready for your intended operation.	Press SOUND or source selecting buttons first, then press the button you want to use. (See pages 40 and 41.)
Remote control does not work.	There is an obstruction hiding the remote sensor on the unit.	Remove the obstruction.
	Batteries are weak.	Replace batteries.
	RDS/DVD MENU mode selector is set to the wrong position.	Set RDS/DVD MENU mode selector to the proper position.

Note:

When you use the digital coaxial connection, the sounds may be intermitted by the outside noise such as a lightning discharge but they will restore automatically. This is not a malfunction.

Amplifier

Output Power	At Stereo operation:	
	Front channels:	50 W per channel, min. RMS, Both channels driven into 8 Ω at 1kHz with no more than 0.9% total harmonic distortion. (IEC268-3/DIN)
	At Surround operation:	
	Front channels:	50 W per channel, min. RMS, driven into 8 Ω at 1 kHz with no more than 0.8% total harmonic distortion.
	Center channel:	50 W, min. RMS, driven into 8 Ω at 1 kHz, with no more than 0.8% total harmonic distortion.
	Rear channels:	50 W per channel, min. RMS, driven into 8 Ω at 1 kHz, with no more than 0.8% total harmonic distortion.

Audio

Audio Input Sensitivity/Impedance (1 kHz):	DVD, STB, VCR, TV, TAPE:	180 mV/47 kΩ
Audio Input (DIGITAL IN)* :	Coaxial: DIGITAL 1 (DVD):	0.5 V _{p-p} /75 Ω
	Optical: DIGITAL 2 (STB):	-21 dBm to -15 dBm (660 nm ±30 nm)
	* Corresponding to Linear PCM, Dolby Digital, and DTS Digital Surround (with sampling frequency — 32 kHz, 44.1 kHz, 48 kHz).	
Audio Output Level:	VCR, TV, TAPE:	180 mV
Signal-to-Noise Ratio (ˆ66 IHF/DIN):	DVD, STB, VCR, TV, TAPE:	85 dB/62 dB
Frequency Response (8 Ω):	DVD, STB, VCR, TV, TAPE:	20 Hz to 20 kHz (±1 dB)
Tone Control:	Bass (100 Hz):	±10 dB
	Treble (10 kHz):	±10 dB
Bass Boost:	+6 dB ± 1 dB at 70 Hz	

Video

Video Input Sensitivity/Impedance (1 kHz):	DVD, STB, VCR, TV: 1 V _{p-p} /75 Ω	
Composite video:	DVD, STB, VCR:	(Y:luminance): 1 V _{p-p} /75 Ω
S-VIDEO:		(C:chrominance): 0.286 V _{p-p} /75 Ω
RGB:	DVD, STB, VCR:	0.7 V _{p-p} /75 Ω
Video Output Level/Impedance (1 kHz):	VCR, TV: 1 V _{p-p} /75 Ω	
Composite video:	TV:	(Y:luminance): 1 V _{p-p} /75 Ω
S-VIDEO:		(C:chrominance): 0.286 V _{p-p} /75 Ω
RGB:	TV:	0.7 V _{p-p} /75 Ω
Signal-to-Noise Ratio (S/N):	45 dB	
Synchronize:	Negative	

FM tuner (IHF)

Tuning Range:	87.50 MHz to 108.00 MHz	
Usable Sensitivity:	Monaural:	17.0 dBf (1.95 μV/75 Ω)
50 dB Quieting Sensitivity:	Monaural:	21.3 dBf (3.2 μV/75 Ω)
	Stereo:	41.3 dBf (31.5 μV/75 Ω)
Signal-to-Noise Ratio (IHF-A weighted):	Monaural:	78 dB at 85 dBf
	Stereo:	73 dB at 85 dBf
Total Harmonic Distortion:	Monaural:	0.4% at 1 kHz
	Stereo:	0.6% at 1 kHz
Stereo Separation at REC OUT:	35 dB at 1 kHz	
Alternate Channel Selectivity:	60 dB: (±400 kHz)	
Frequency Response:	30 Hz to 15 kHz: (+0.5 dB, -3 dB)	

AM (MW/LW) tuner

Tuning Range:	MW:	522 kHz to 1 629 kHz
	LW:	144 kHz to 288 kHz
Usable Sensitivity:	Loop antenna	400 μV/m (MW)
Signal-to-Noise Ratio:	50 dB (100 mV/m)	

General

Power Requirements:	AC 230V ~, 50 Hz
Power Consumption:	110 W (at operation) 2 W (in standby mode)
Dimensions (W x H x D):	17 ³ / ₁₆ in. x 3 ¹⁵ / ₁₆ in. x 15 ¹¹ / ₁₆ in. (435 mm x 100 mm x 398 mm)
Mass:	16.4 lbs (7.4 kg)

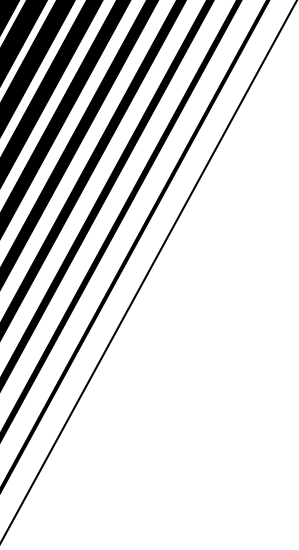

JVC
VICTOR COMPANY OF JAPAN, LIMITED