

Time Delay Relays

Plug-in Time Delay Relays

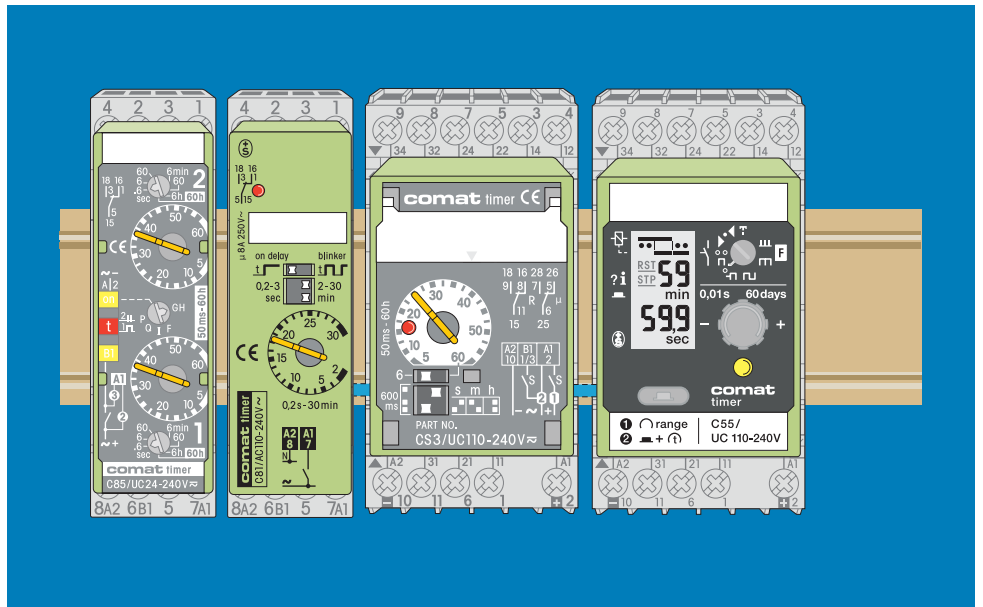

- Multifunction Time Delay Relays
- Restart Delay Relays

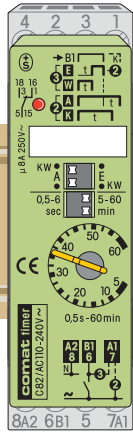
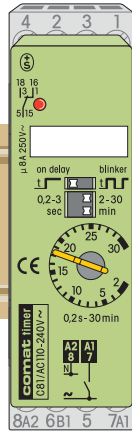
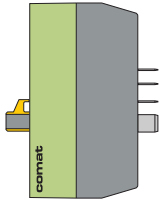

22,5 mm Plug-in Time Delay Relay System for all delay, shot timing and blinking functions. Double functions, repeat cycle timing and functions without auxiliary voltage.

C81

Economy Time Delay Relay on delay or blinking, voltage controlled, output-LED.

C82

Economy Time Delay Relay on delay, off delay, one shot leading edge, pulse shaping K, voltage controlled, output-LED.

C83

Universal Multifunctional Time Delay Relay
 • 12 functions + ON (Test), voltage controlled.
 • Time lapse display (double blinking = t2)
 • Input-LED (24-240V)
 • Output-LED
 • Seismic approved.

C84

Time Delay Relay, no auxiliary voltage
 • Off delay
 • One shot trailing edge
 • Triggering display
 • Minimum triggering time 150 ms only
 • Seismic approved.

C85

Double Time Delay Relay and Repeat Cycle Timer
 • 6 functions + test
 • t1/t2 separately settable
 • Time lapse display (double blinking = t2)
 • Input-LED (24-240V)
 • Output-LED
 • Seismic approved.

E **1** Triggering Function (page *)

E B2 **1**

E **23**
A K **2** **W** **3**

E **23** **W H B** **3** **2**
A N L F K G B1 Q

A N **1**
no auxiliary voltage

I P **23**
F Q G **2** **H** **3**

Time range
★ TF60 setting (page *)

0,2s-30min
0,2-3s...2-30min

0,5s-60min
0,5-6s...5-60min

50ms-60h★
50-600ms...5-60h

0,1s-20min
0,1-1,2s...1,7-20min

2x 50ms-60h★
2x 50-600ms...5-60h

μ MAX

8A 250V~

8A 250V~

8A 250V~

5A 250V~

8A 250V~

Triggering

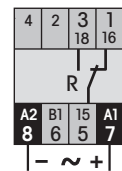
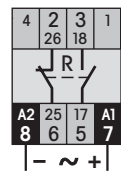
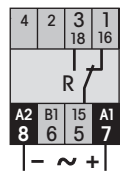
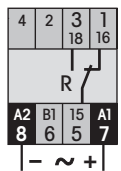
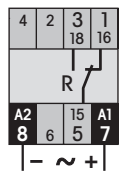
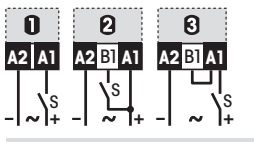

~ AC 50/60Hz

AC110-240V

AC110-240V

AC230V

AC115V

UC24-240V

UC24V

UC110-240V

UC24-48V

AC230V

AC115V

UC24-240V

UC24V

Ordering no. →

C81 / ...V

C82 / ...V

C83 / ...V

C84 / ...V

C85 / ...V

System socket CS-18
Figure: with inserted retaining clips
(standard delivery with relay)

F Q **G H**
t2=t1 t2=0,5s

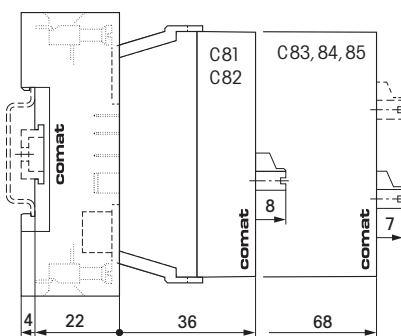
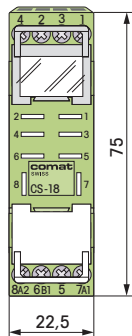

Ordering example

Timer C83/UC24-240V
Socket CS18

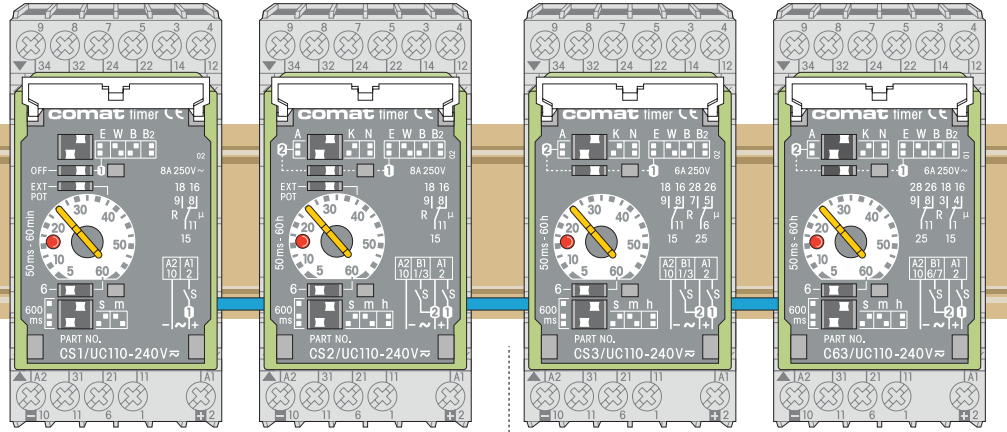
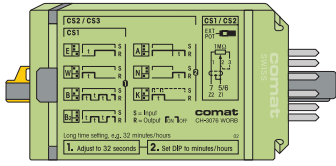

11-pole Plug-in Time Delay Relay System for all delay, short timing and blinking functions from 50 ms up to 60 hours. CS1, CS2 with connection for remote potentiometer. Front panel mounting with FZ-50.

E **1** Triggering
Function (page *)

Time range
★ TF60 setting (page *)

μ¹ MAX

Triggering

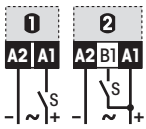

UC AC/DC

Ordering no. →

CS1

Economy Time Delay and Blinker Relay
With additional connection for remote potentiometer SP-01/1M (up to 50m).

Replaces fully compatible **CSE2, CSB2**



50 ms - 60 min ★
50-600ms...5-60min

8 A 250V~

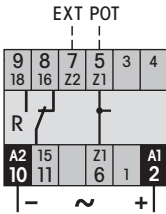

UC110-240V
UC24-60V

CS1 / ...V

CS2

Universal Multifunctional Time Delay Relay like CS1, but with 7 functions and delay times up to 60 hours.

Replaces fully compatible **CSA2, CSK2, CSN2**



50 ms - 60h ★
50-600ms...5-60h

8 A 250V~

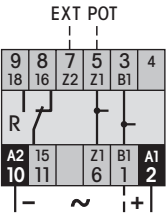

UC110-240V
UC24-60V
UC12-15V

CS2 / ...V

CS3 (2nd contact: 6-5-7)

Universal Multifunctional Time Delay Relay like CS2, but with 2nd contact instead of Z1-Z2 (terminal 6-5-7).

Replaces fully compatible **CSE3, CSA3**



50 ms - 60h ★
50-600ms...5-60h

6 A 250V~

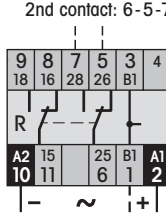

UC110-240V
UC24-60V
UC12-15V

CS3 / ...V

C63 (2nd contact: 1-4-3)

Universal Multifunctional Time Delay Relay like CS3, but with 2nd contact on terminal 1-4-3.

Replaces fully compatible **CX35, CX36**



50 ms - 60h ★
50-600ms...5-60h

6 A 250V~

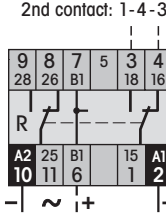

UC110-240V
UC24-60V
UC12-15V

C63 / ...V

System socket C11A

Figure: with plug-in neutral conductor connector C-A2 (standard delivery).

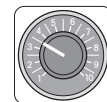
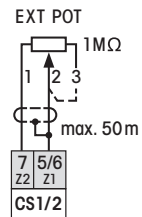
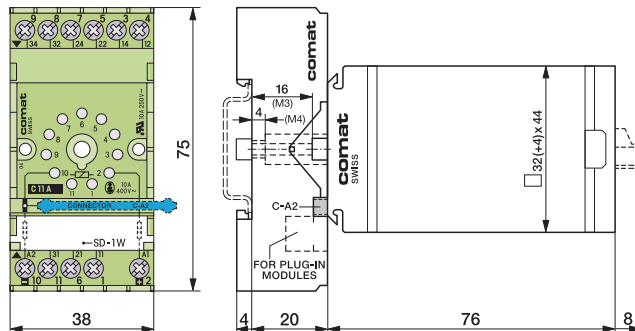

Built-in potentiometer **SP-01/1M** (page *)

Ordering example

Timer **CS2/UC110-240V**
Socket **C11A**

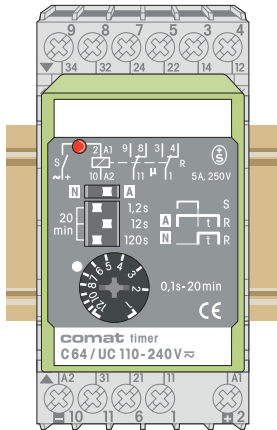

C64

Time Delay Relay without auxiliary voltage

True off delay or one shot trailing edge after cut off power supply.
Minimum triggering time 150ms only.
Seismic approved.

Replaces RS124, CSR2

A N 1

without auxiliary voltage

0,1s-20 min

0,1-1,2s...1,7-20 min

5 A 250V~

Do not connect 5-6-7!

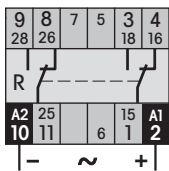

UC110-240V

UC24-60V

C64 / ...V

Ordering example

Timer C64/UC110-240V
Socket C11A

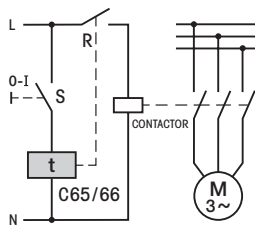

X1 Function (page *)

1 Triggering

Time range

Partial ranges

Triggering

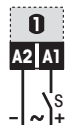

~ AC

Ordering no. →

System socket C11A

Figure: with plug-in neutral conductor connector C-A2 (standard delivery).

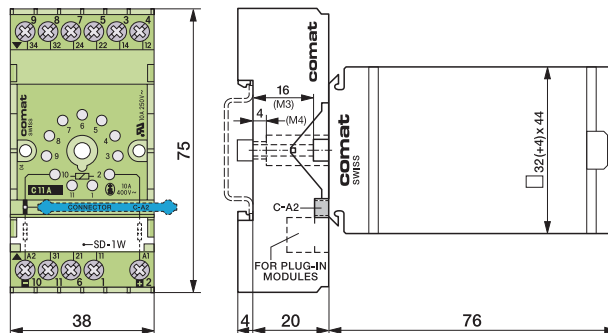

Ordering example

Timer C65/AC230V
Socket C11A

Restart Delay Relay

NO UNDEFINED PROCESS CONDITIONS AFTER MAINS INTERRUPTION

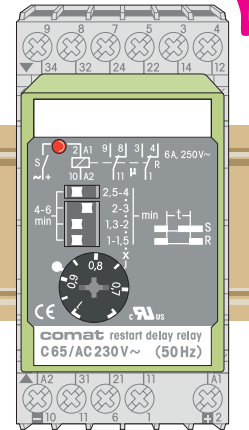

C65 (50Hz) C66 (60Hz)

Restart Delay Relay

The C65 (50Hz) and C66 (60Hz) are special timers with no auxiliary voltage to guarantee a minimum OFF time after removal of supply. After the interruption of supply, the device will not reclose before the set time (1-6 mins.) has elapsed,

even if there has been a new command to switch ON. Typical application: After a mains failure it is not possible to restart (close contacts) before the machine is at rest. Example: Motor (see diagram on the left).

X1



1-6 min

1-1,5 ... 4-6 min

6 A 250V~

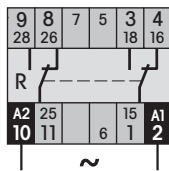

~ 50Hz

AC230V

AC115V

C65 / ...V

~ 60Hz

AC230V

AC115V

C66 / ...V

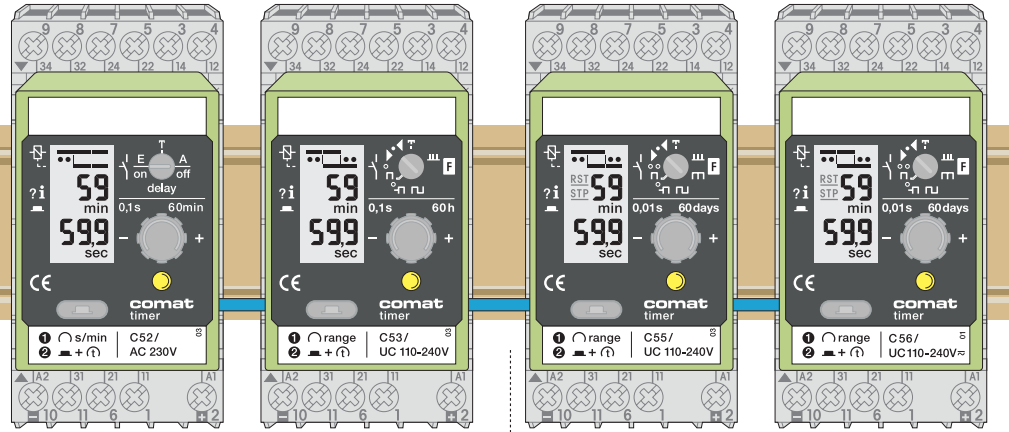
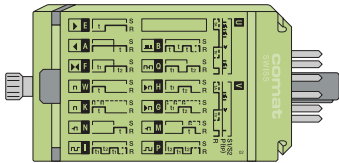

11-pole Plug-in Time Delay Relay System for all timing modes from 10 ms up to 60 days. Extremely accurate due to quartz time base. Digital functions and residual time display. Front panel mounting with FZ-50. Test function ∇ .

- | | | | |
|--|---|---|--|
| <p>C52</p> <p>Universal Multifunctional Time Delay Relay</p> <ul style="list-style-type: none"> • 2 functions • 0.1s - 60 min (quartz) • 1 change-over contact | <p>C53 (C53.3, C53.4)</p> <p>Universal Multifunctional Time Delay Relay</p> <ul style="list-style-type: none"> • 10 functions • 0.1s - 60 h (quartz) • 1 change-over contact • Alternatively solid-state output .3 or .4 | <p>C55 (C55.3, C55.4)</p> <p>Universal Multifunctional Time Delay Relay</p> <ul style="list-style-type: none"> • 15 functions incl. Puls sequence monitoring (U/V) • 0.01s - 60 days (quartz) • Setting step up to 60s : 1ms • t-STOP and t-RESET input • 2 changeover contacts • Alternatively solid-state output .3 or .4 • Seismic approved) | <p>C56</p> <p>Universal Multifunctional Time Delay Relay like type C55, but with potential free triggering of START, STOP and RESET (insulation from 2-10: 2 kV).</p> |
|--|---|---|--|

E-1 Triggering
Function (page *)

E-2-3	E W H B I-2-3	E W H B I P-2-3	E W H B I P-2-3
A-2	A K N F Q-2	A K N M G F Q-2	A K N M G F Q-2
		U V-3	U V-3

Time range
Partial ranges

0,1s - 60 min	0,1s - 60h 0,1s - 60 min ... 0,1 min - 60h	0,01s - 60 days 0,01 - 60s ... 0,1 h - 60 days	0,01s - 60 days 0,01 - 60s ... 0,1 h - 60 days
---------------	---	---	---

μ \ MAX

8A 250V~	8A 250V~	5A 250V~	5A 250V~
-----------------	-----------------	-----------------	-----------------

Triggering

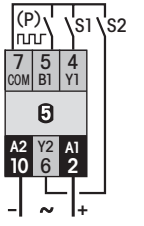
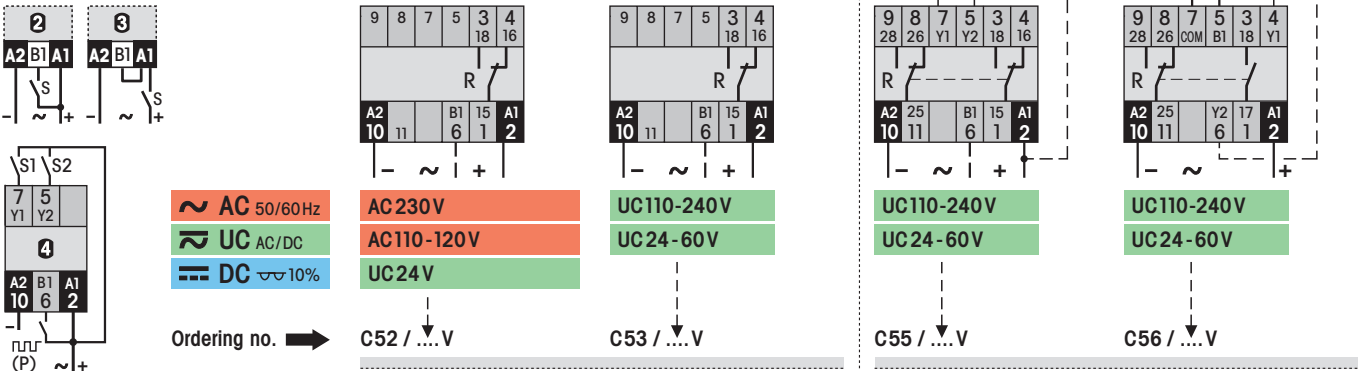

System socket C11A
Figure: with plug-in neutral conductor connector C-A2 (standard delivery).

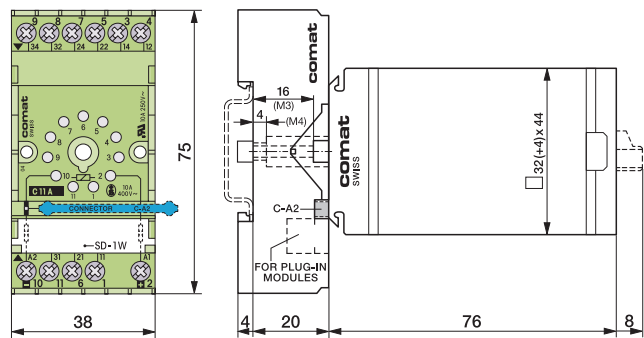

Ordering example

Timer C53/UC110-240V
Socket C11A

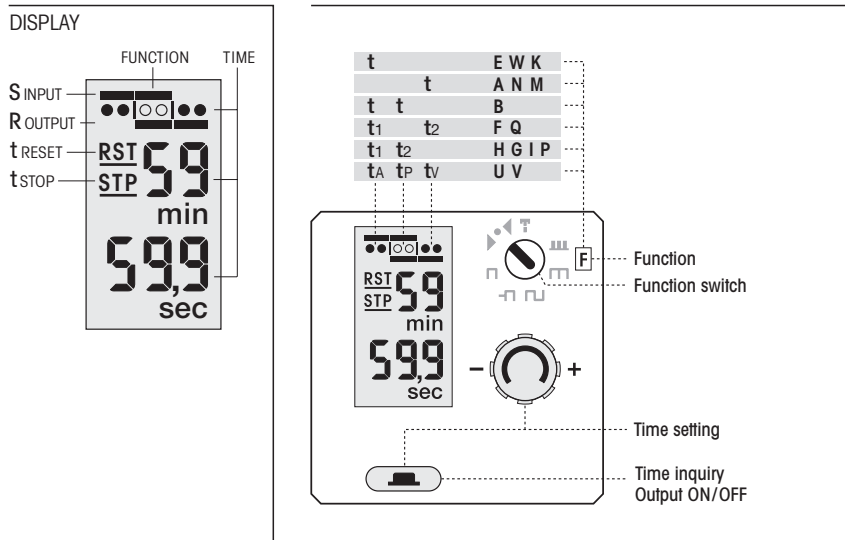

Option*

Solid-state output for C53, C55
(instead of contact)

C53.3
C55.3

For AC or DC load
0,5A 10-265V \approx

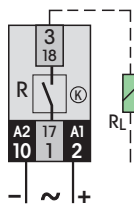

UC110-240V
UC24-60V

C53.3 / ...V
C55.3 / ...V

C53.4
C55.4

For DC load
2A 24V \approx

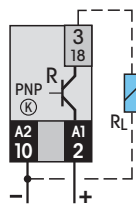

DC24V

C53.4 / ...V
C55.4 / ...V



Kühn Controls AG

Notes:

You want more information about this product, please call us: tel: +49 (0)7082-940000 or send us a fax: +49 (0)7082-940001, or email: sales@kuehn-controls.de or visit our Website: www.kuehn-controls.de