

Powered by



HRL 1234W ▶ 12V 34W

HRL 1234W is specially designed for high efficient discharge application. Its characteristics are high energy density, small footprint and high discharge efficiency. It can be used for more than 260 cycles at 100% discharge in cycle service, up to 8 years in standby service.



► Specification

Cells per unit	6
Voltage per unit	12
Capacity	34W @ 15min-rate to 1.67V per cell @25 °C(77°F)
Weight	Approx.2.7 kg(5.95 lbs)
Maximum Discharge Current	130A(5sec)
Internal Resistance	Approx. 17mΩ
Operating Temperature Range	Discharge: -15°C~50°C(5°F~122°F) Charge: -15 °C~40°C(5°F~104°F) Storage: -15°C~40°C(5°F~104°F)
Nominal Operating Temperature Range	25°C±3°C (77°F±5°F)
Float Charging Voltage	13.5 to 13.8 VDC/unit Average at 25°C (77°F)
Recommended Maximum Charging Current Limit	3.4A
Equalization and Cycle Service	14.4 to 15.0 VDC/unit Average at 25°C (77°F)
Self Discharge	CSB Batteries can be stored for more than 6 months at 25°C (77°F). Please charge batteries before using. For higher temperatures the time interval will be shorter.
Terminal	F2-Faston Tab 250
Container Material	ABS(UL 94-HB/File E50263)*Flammability resistance of (UL 94-V0/File E88637) can be available upon request.



CSB-manufactured VRLA batteries are UL-recognized components under UL924 and UL1989.

CSB is also certified by ISO 9001 and ISO 14001.

Dimensions :	Overall Height (H)	Container height (h)	Length (L)	Width (W)
Unit: mm (inch)	98.3±1 (3.87±0.04)	94±1 (3.7±0.04)	151±2 (5.94±0.08)	65±1 (2.55±0.04)

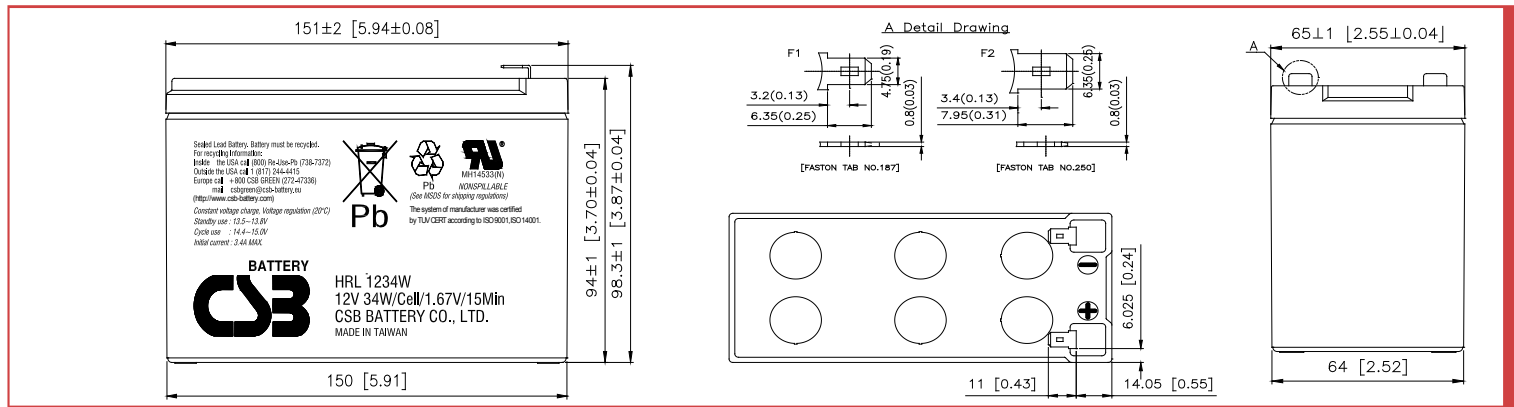

Constant Current Discharge Characteristics Unit:A (25°C, 77°F)

F.V/Time	2MIN	4MIN	6MIN	8MIN	10MIN	15MIN	20MIN	30MIN	60MIN	90MIN
1.60V	66.0	45.0	34.5	28.0	24.0	17.6	14.0	10.1	5.69	4.00
1.67V	58.0	41.0	32.3	27.1	23.5	17.4	13.8	9.90	5.61	3.96
1.70V	54.4	39.1	31.3	26.4	23.1	17.2	13.7	9.83	5.57	3.93
1.75V	48.5	35.9	29.4	25.0	22.1	16.8	13.4	9.68	5.50	3.87
1.80V	42.5	32.8	27.0	23.2	20.6	15.8	12.8	9.33	5.36	3.80
1.85V	36.6	29.6	24.6	21.1	18.8	14.4	11.7	8.71	5.06	3.62

Constant Power Discharge Characteristics Unit:W (25°C, 77°F)

F.V/Time	2MIN	4MIN	6MIN	8MIN	10MIN	15MIN	20MIN	30MIN	60MIN	90MIN
1.60V	643	465	375	306	265	205	159	115	65.9	46.7
1.67V	581	435	354	299	262	204	158	114	65.4	46.6
1.70V	550	419	342	293	259	202	155	111	64.6	46.4
1.75V	503	393	324	280	251	198	152	109	63.9	46.0
1.80V	456	367	307	266	238	189	147	108	62.9	45.1
1.85V	409	341	284	246	217	174	137	102	60.2	43.4

Trickle (or Float) Service Life

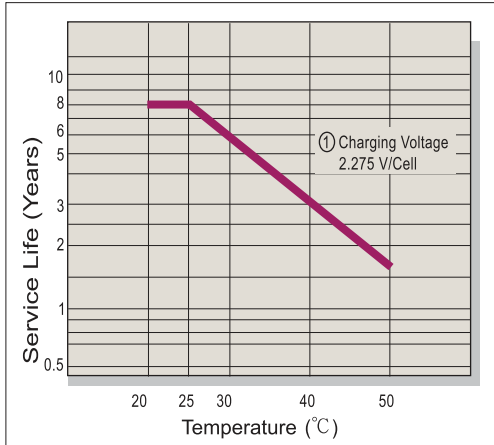

Capacity Retention Characteristic

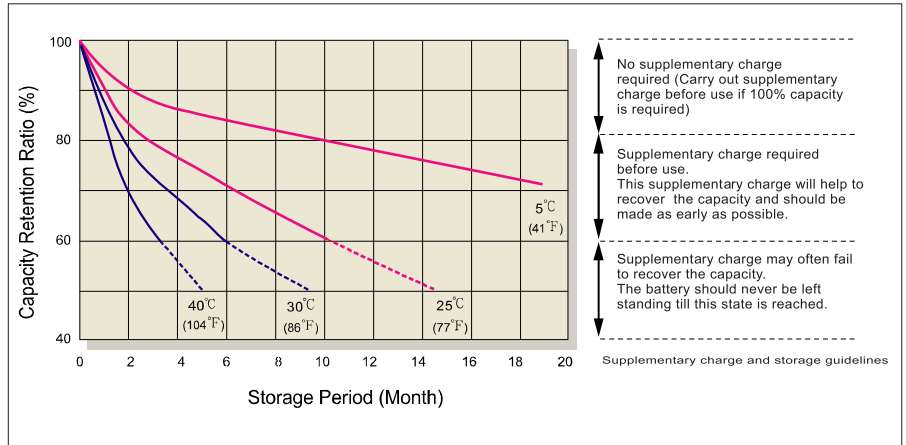

Battery Voltage and Charge Time for Standby Use

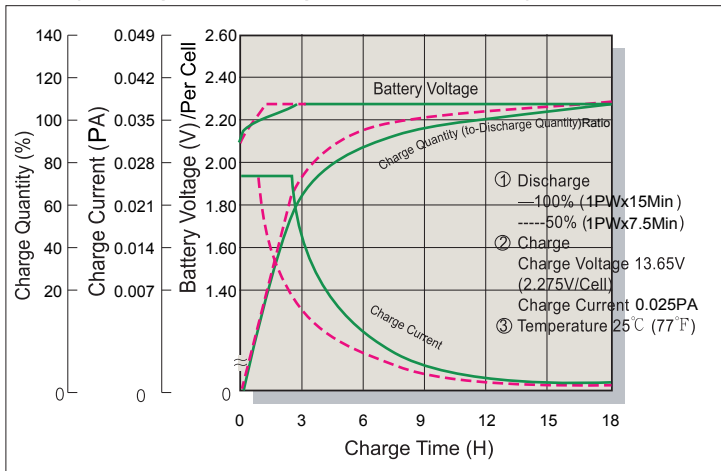

Cycle Service Life

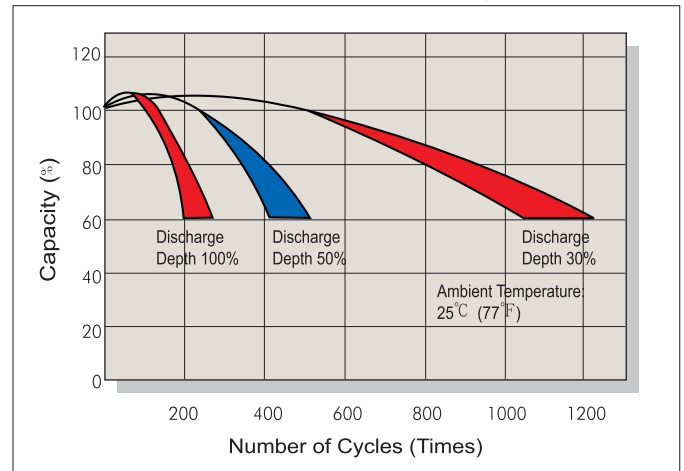

Battery Voltage and Charge Time for Cycle Use

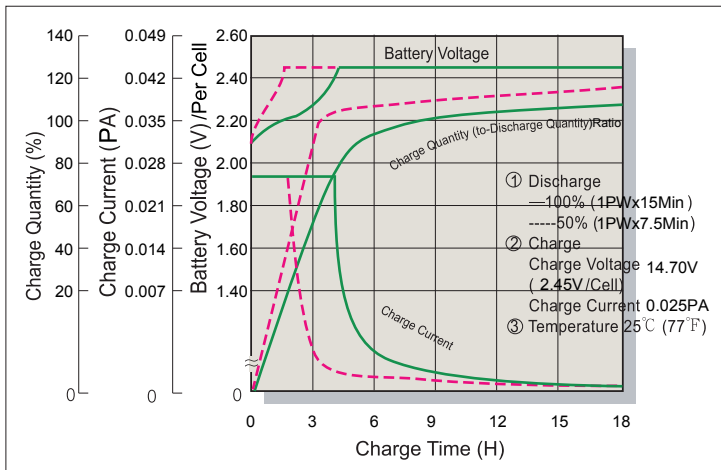

Terminal Voltage (V) and Discharge Time

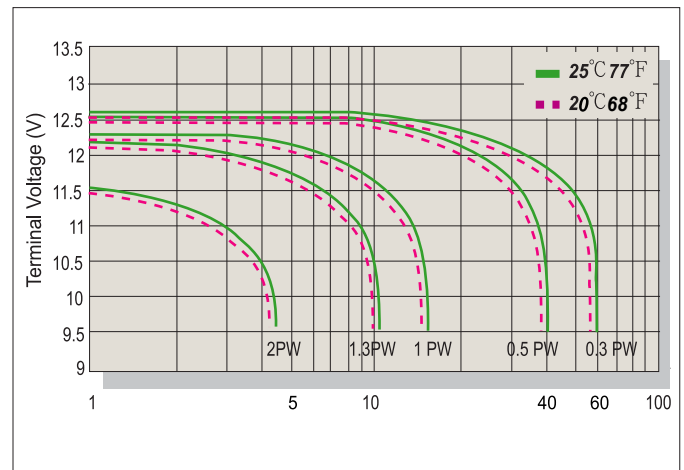

Charging Procedures

Application	Charge Voltage(V/Cell)			Max.Charge Current
	Temperature	Set Point	Allowable Range	
Cycle Use	25°C(77°F)	2.45	2.40~2.50	0.1PA
Standby	25°C(77°F)	2.275	2.25~2.30	

Discharge Current VS. Discharge Voltage

Final Discharge Voltage V/Cell	1.75	1.70	1.60	1.30
Discharge Power(W)	0.1P>(W)	0.1P≤(W)<0.25P	0.25P≤(W)<1.0P	(W)≥1.0P

Sales Office URL: WWW.CSB-BATTERY.COM

Distribution Deutschland ZDIS GmbH

Tel : +49 (0)8638-981 606-0
 Fax : +49 (0)8638-981 606-9
 mail : vertrieb@zdis.de

BEIJING OFFICE. (CHINA)

CSB BATTERY TECHNOLOGIES (BEIJING) CO., LTD.
 Tel : +86-10-59621300/1301/1302/1303
 Fax : +86-10-59621304
 mail : chinasls@csb-battery.com

AMERICA HQ

CSB BATTERY TECHNOLOGIES INC. (U.S.A)
 Tel : +1-817-244-7777/1-(800)3-CSB-USA(272872)
 Fax : +1-817-244-4445
 mail : csb@csb-battery.com

SHANGHAI OFFICE. (CHINA)

CSB BATTERY LOGISTIC (SHANGHAI) CO., LTD.
 Tel : +86-21-5046-1622/5046-0833
 Fax : +86-21-5064-3314
 mail : chinasls@csb-battery.com

EUROPE HQ

CSB Battery Europe BV.
 Tel : +31(0)-180-418-140
 Fax : +886-2-2555-3300
 mail : eurosales@csb-battery.eu

SHENZHEN OFFICE. (CHINA)

CSB BATTERY LOGISTIC (SHANGHAI) CO., LTD.
 Tel : +86-755-8831-6488/6396/6356
 Fax : +86-755-8831-6548
 mail : she@csb-battery.com.cn